

27W / 1960lm / 3000K / DALI / Flood 52° /
1200mm

61287



Structure

- 1 Profile
- 2 End caps
- 3 Fitting accessories
- 4 Profile coupling

Modules

- A inVision Module

Design: O/M + Bartenbach GmbH
Módulo inVision em alumínio com face metálica perfurada e acabamento com pintura texturada.

LED CRI>90 / >50.000h, L80/B10 / 2-step MacAdam
Fonte de alimentação incluída.
IP20 | 230Vac | 50/60Hz



LED	3000K	Fonte de Luz	Luminária
Potência	27W		32,9W
Fluxo	2580lm		1960lm
Eficiência	96lm/W		60lm/W
LOR	-		76%
UGR	-		<10



Ângulo de abertura
Flood 52°

Aplicação



Peso
0,8Kg

mm

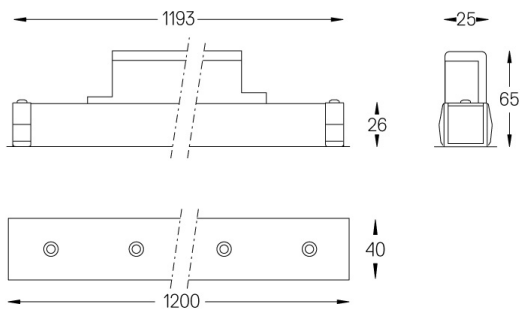

Acabamentos

- .01 Branco / RAL 9010
- .02 Preto / RAL 9005

Para fornecimento específico de drivers "DALI 2" por favor contactar:
support@om-light.com

Choose the length and layout of the system exactly as you want it, to model the right lighting functions for different tasks. For further information please contact: support@om-light.com