

27W / 1760lm / 2700K / On/Off / Medium 31°
/ 1200mm

61261



Structure

- 1 Profile
- 2 End caps
- 3 Fitting accessories
- 4 Profile coupling

Modules

- A inVision Module

Design: O/M + Bartenbach GmbH

Módulo inVision em alumínio com face metálica perfurada e acabamento com pintura texturada.

LED CRI>90 / >50.000h, L80/B10 / 2-step MacAdam

Fonte de alimentação incluída.

IP20 | 230Vac | 50/60Hz



LED	2700K	Fonte de Luz	Luminária
Potência	27W	32,9W	
Fluxo	2400lm	1760lm	
Eficiência	89lm/W	53lm/W	
LOR	-	73%	
UGR	-	<10	

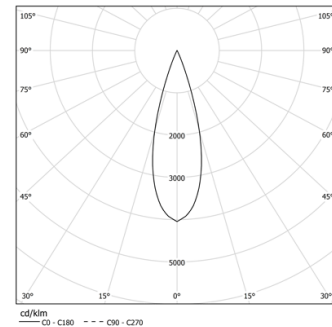

Ângulo de abertura
Medium 31°

Aplicação



Peso
0,8Kg

mm

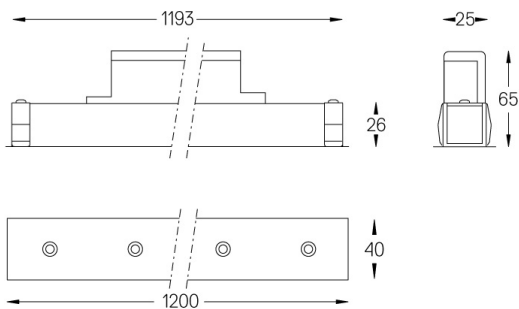

Acabamentos

- .01 Branco / RAL 9010
- .02 Preto / RAL 9005

Choose the length and layout of the system exactly as you want it, to model the right lighting functions for different tasks. For further information please contact: support@om-light.com