



Installation Instructions

01



Ø65mm



≥40mm



12,5-25mm



Ø45 ≥145mm
Ø60 ≥105mm



230 Vac





OFF

02



1



2



≥85mm

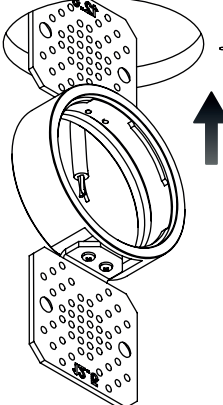

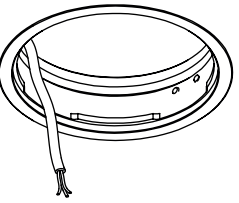
03

04



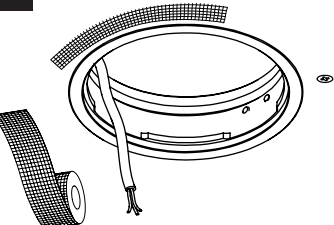

05

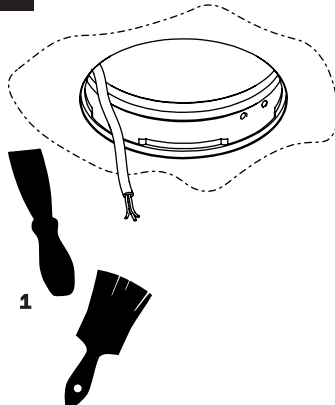

1

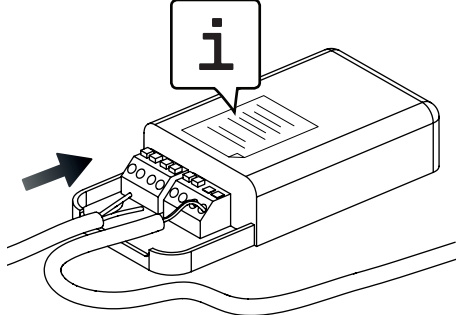
06

06

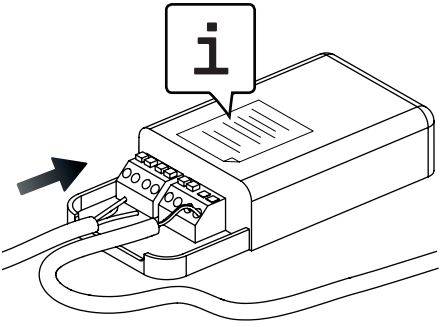

07

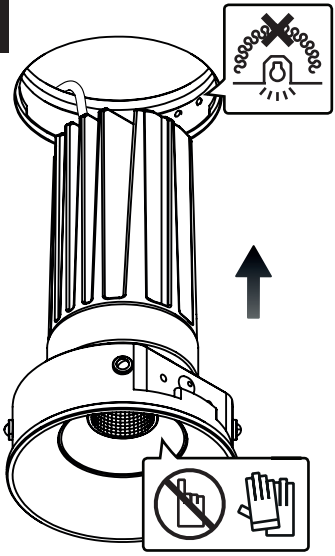

✓

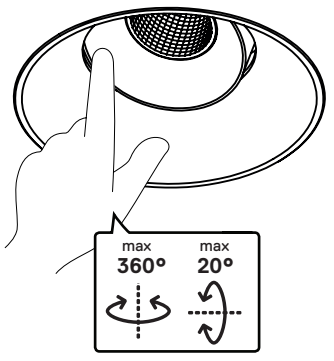

ON



www.om-light.com



Read the instructions carefully before installation and commissioning.



Our updated product documentation can be accessed at www.om-light.com.

General safety information



Warning!
Risk of electric shock!

Before carrying out installation and maintenance on the luminaire, disconnect from the main supply and also from any other DALI control wiring and ensure that all power is switched off.



Caution!
Blue light hazard!

Do not open the luminaire. In case of damage or defective LED module, the entire luminaire must be returned to the factory.

When installing, always observe the national installation and accident prevention regulations.



Luminaire not suitable for covering with thermal insulation material.

Lateral air space under EN 60598:

The lateral distance between the surface of the luminaire and any parts of the building must be no less than 5cm.

The luminaire must be positioned so as to avoid operation in direct sunlight or near other sources of heat. High ambient temperatures reduce the life and efficiency of the control gear or LED module.



Electric Installation and procedures.

Please position the control gear at least 10cm from the luminaire. The interconnection cables between the LED and the luminaire must have at max. 2 metres long. Avoid crossing cables.

Do not disconnect the electrical connection between the luminaire and control gear. This cause damage to the luminaire and/or control gear.

For 3-circuit installation: to avoid any damage to control gear, the neutral conductor must never be connected or disconnected during operation.

O/M uses electronic control gears with overvoltage protection in accordance with DIN EN 61547. If additional protection from spikes is required, e.g. when switching off inductive loads, separate overvoltage protection units should be installed.

For luminaires with DALI control gears, all cables, materials and devices used must be suitable for main voltage, as DALI signal is not transmitted using safety extra low voltage (SELV).

General information on DALI is available at www.digitalilluminationinterface.org.

Dimming: Depending on the model, the luminaire can be dimmed using DALI.

Before installation and connection, check luminaire, control gear and dimmer combination for proper functioning of the dimmer, especially when using universal dimmers.

The use of dimmers which are unsuitable for LED drivers can damage the luminaire, control gear and/or the dimmer.

No responsibility is accepted for the misuse or use of dimmers which are unsuitable for the O/M luminaires.

For further information please contact O/M Light or one of its distributors.



Cleaning procedures and tips.

Products should be cleaned regularly, depending on the level of dirt in the installation environment, with warm water (60°C max.) or neutral, non-abrasive water based detergents.



Disposal and ecological procedures.

In accordance with EU Directive WEEE (Waste Electrical and Electronic Equipment), luminaires must not be disposed of with other household waste.

At the end of their life, luminaires must be taken to the appropriate local facilities available for the disposal or recycling of electronic products.

Contact



O/M Headquarters.

For technical and installation support, please contact us:

www.om-light.com
support@om-light.com
+351 223 710 419

Rua Maurício Lourenço Oliveira, nº186
4405-034 Madalena, VNG Portugal