

5,6W / 215lm / 4000K / On/Off / Spot 16° / ø45mm

64890



Design: O/M + Bartenbach GmbH

Surface spotlight with die-cast aluminium body with electrostatic 100% polyester paint finish.

Spot-lens with individual complex surface rips to provide a focal light and an extremely narrow beam. Orientable by 150° horizontal rotation and 330° vertical rotation.

Driver to be ordered separately.

LED CRI>90 / >50.000h, L80/B10

2-step MacAdam / Driver to be ordered separately.

IP20 / 450mA



LED	4000K	Light Source	Luminaire
Power		5,6W	5,6W
Flux		480lm	215lm
Efficiency		86lm/W	31lm/W
LOR		-	45%
Operating Condition		-	Current Source

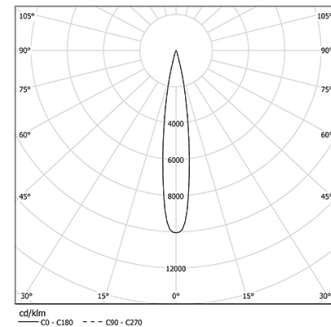

Beam angle
Spot 16°

Application

Weight
0,30Kg

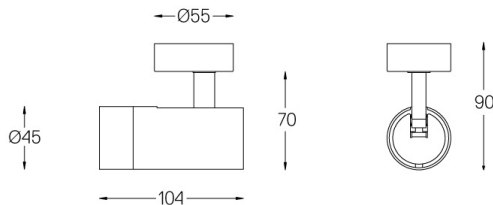

Finishes

- .01 White / RAL 9010
- .02 Black / RAL 9005

Mandatory

- 59084** Driver On/Off [Up to 2 luminaires]
140x30x21mm
- 59085** Driver On/Off [Up to 3 luminaires]
163x30x21mm
- 59086** Driver DALI [Up to 2 luminaires]
140x30x21mm
- 59087** Driver DALI [Up to 3 luminaires]
163x30x21mm

Optional

- 59072** 1/4 CTO
ø35x1,1mm
- 59073** 1/2 CTO
ø35x1,1mm
- 59074** Louvre
ø35x2mm
- 59075** Soft diffuser
ø35x2mm