

5,6W / 410lm / 3000K / On/Off / Flood 56° / ø45mm

64889



Design: O/M + Bartenbach GmbH
 Surface spotlight with die-cast aluminium body with electrostatic 100% polyester paint finish.
 Orientable by 150° horizontal rotation and 330° vertical rotation.
 Driver to be ordered separately.

LED CRI>90 / >50.000h, L80/B10
 2-step MacAdam / Driver to be ordered separately.
 IP20 / 450mA



LED	3000K	Light Source	Luminaire
Power		5,6W	5,6W
Flux		460lm	410lm
Efficiency		82lm/W	59lm/W
LOR		-	89%
Operating Condition		-	Current source

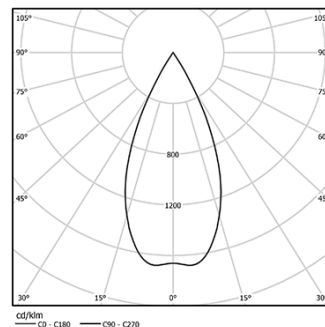

Beam angle
Flood 56°

Application

Weight
0,30Kg

mm

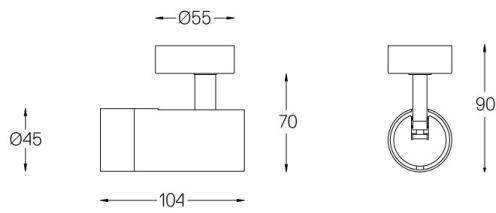

Finishes

- .01 White / RAL 9010
- .02 Black / RAL 9005

Mandatory

59084 Driver On/Off [Up to 2 luminaires]

140x30x21mm

59085 Driver On/Off [Up to 3 luminaires]

163x30x21mm

59086 Driver DALI [Up to 2 luminaires]

140x30x21mm

59087 Driver DALI [Up to 3 luminaires]

163x30x21mm

Optional

59072 1/4 CTO

ø35x1,1mm

59073 1/2 CTO

ø35x1,1mm

59074 Louvre

ø35x2mm

59075 Soft diffuser

ø35x2mm

Data according to regulations

2019/2020/EU supplemented by 2021/341 | 2019/2015/EU
supplemented by 2021/340/EU Energy Consumption Labelling
Ordinance. This product contains a light source of efficiency class G
Model Identifier 4053560290L