

5,6W / 200lm / 3000K / On/Off / Spot 16° / ø45mm

64887



Design: O/M + Bartenbach GmbH

Surface spotlight with die-cast aluminium body with electrostatic 100% polyester paint finish.

Spot-lens with individual complex surface rips to provide a focal light and an extremely narrow beam. Orientable by 150° horizontal rotation and 330° vertical rotation.

Driver to be ordered separately.

LED CRI>90 / >50.000h, L80/B10

2-step MacAdam / Driver to be ordered separately.

IP20 / 450mA



| LED 3000K           | Light Source | Luminaire      |
|---------------------|--------------|----------------|
| Power               | 5,6W         | 5,6W           |
| Flux                | 440lm        | 200lm          |
| Efficiency          | 79lm/W       | 29lm/W         |
| LOR                 | -            | 45%            |
| Operating Condition | -            | Current source |

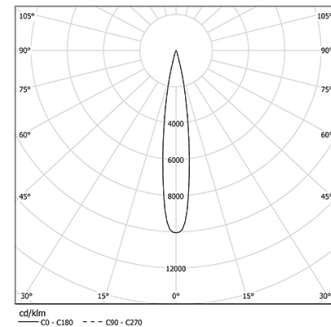

Beam angle  
Spot 16°

Application

Weight  
0,30Kg

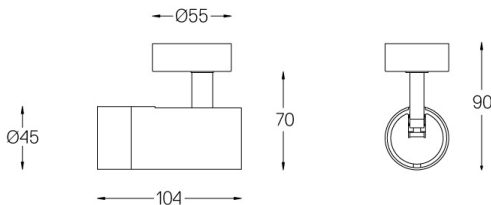

### Finishes

- .01 White / RAL 9010
- .02 Black / RAL 9005

### Mandatory

- 59084** Driver On/Off [Up to 2 luminaires]  
140x30x21mm
- 59085** Driver On/Off [Up to 3 luminaires]  
163x30x21mm
- 59086** Driver DALI [Up to 2 luminaires]  
140x30x21mm
- 59087** Driver DALI [Up to 3 luminaires]  
163x30x21mm

### Optional

- 59072** 1/4 CTO  
ø35x1,1mm
- 59073** 1/2 CTO  
ø35x1,1mm
- 59074** Louvre  
ø35x2mm
- 59075** Soft diffuser  
ø35x2mm