

6,7W / 3,4W / 800lm / 400lm / 3500K / Flood
48° / 75x75mm

64880



Design: O/M

Ceiling-recessed luminaire made of aluminium die-cast.

Recessing system with spring clips.

LED CRI>90 / >50.000h, L80/B10
3-step MacAdam / Power supply not included
IP65 | 200mA / 100mA



LED	3500K	Light Source	Luminaire
Power		6,7W / 3,4W	6,7W / 3,4W
Flux		1055lm / 530lm	800lm / 400lm
Efficiency		157lm/W	119lm/W
LOR		-	76%
UGR		-	<19

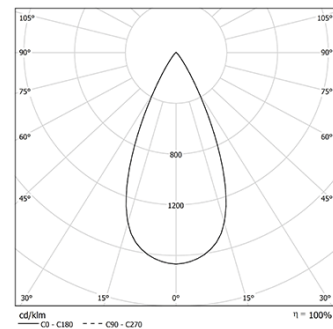

Beam angle
Flood 48°

Application



Weight
0.21Kg

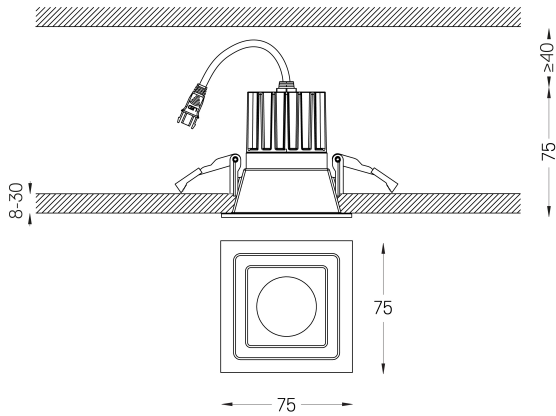

Finishes

- .04 Matt White
- .05 Matt Black

Mandatory

59101 Driver On/Off [200mA]

147x43x30mm

59100 Driver On/Off [100mA]

110x40x21mm

59103 Driver DALI [200mA]

144x30x21mm

59102 Driver DALI [100mA]

144x30x21mm

59105 Driver PhaseCut [180mA]

102x49x29mm

59104 Driver PhaseCut [100mA]

122x41x23mm

59107 Driver 1-10V [200mA]

130x30x20mm

59106 Driver 1-10V [120mA]

130x30x20mm

The cutout dimensions are for plasterboard ceilings. For other type of material please contact: support@om-light.com

The 5-year guarantee applies only when the luminaire and driver are supplied together.

Data according to regulations

2019/2020/EU supplemented by 2021/341 [2019/2015/EU

supplemented by 2021/340/EU Energy Consumption Labelling

Ordinance. This product contains a light source of efficiency class E

Model Identifier BXRE-35G10FB-C-83