

6,7W / 3,4W / 800lm / 400lm / 3000K /  
On/Off / Medium 34° / 75x75mm

64876



Design: O/M

Ceiling-recessed luminaire made of aluminium die-cast.

Recessing system with spring clips.

LED CRI>90 / >50.000h, L80/B10  
3-step MacAdam / Power supply not included  
IP65 | 200mA / 100mA



LED	3000K	Light Source	Luminaire
Power		6,7W / 3,4W	6,7W / 3,4W
Flux		1055lm / 530lm	800lm / 400lm
Efficiency		157lm/W	119lm/W
LOR		-	76%
UGR		-	<16

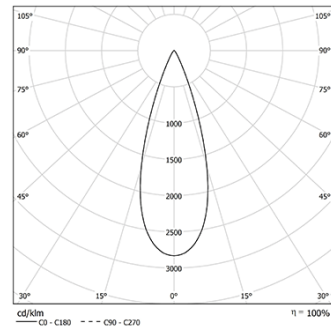

Beam angle  
Medium 34°

Application



Weight  
0.21Kg



## Finishes

- .04 Matt White
- .05 Matt Black

## Mandatory

- 59101** Driver On/Off [200mA]  
147x43x30mm
- 59100** Driver On/Off [100mA]  
110x40x21mm
- 59103** Driver DALI [200mA]  
144x30x21mm
- 59102** Driver DALI [100mA]  
144x30x21mm
- 59105** Driver PhaseCut [180mA]  
102x49x29mm
- 59104** Driver PhaseCut [100mA]  
122x41x23mm
- 59107** Driver 1-10V [200mA]  
130x30x20mm
- 59106** Driver 1-10V [120mA]  
130x30x20mm

The cutout dimensions are for plasterboard ceilings. For other type of material please contact: [support@om-light.com](mailto:support@om-light.com)

The 5-year guarantee applies only when the luminaire and driver are supplied together.

## Data according to regulations

2019/2020/EU supplemented by 2021/341 [2019/2015/EU  
supplemented by 2021/340/EU Energy Consumption Labelling  
Ordinance. This product contains a light source of efficiency class E  
Model Identifier BXRE-30G10FB-C-83



## Go IP65 Square

Driver On/Off [1 luminaire]

59101

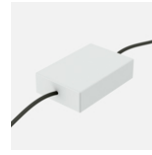

Driver On/Off for Go ø75  
[200mA]  
230Vac | 50/60Hz | Class II

Weight  
0,08Kg

Finishes  
.99

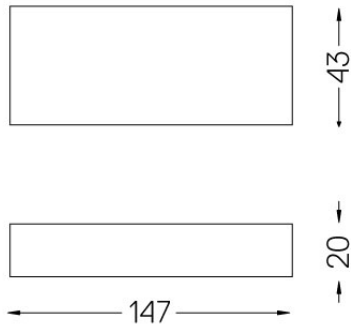



## Go IP65 Square

Driver On/Off [1 luminaire]

59100



Driver On/Off for Go ø75 [100mA]  
230Vac | 50/60Hz | Class II

Weight  
**0,09Kg**

Finishes  
**.99**

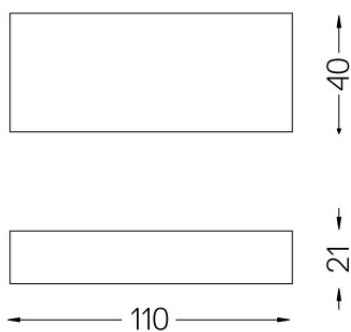

Driver DALI [1 luminaire]

59103

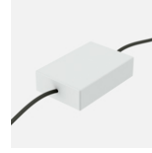

Driver DALI for Go ø75 [200mA]  
230Vac | 50/60Hz | Class II

Weight  
**0,08Kg**

Finishes  
**.99**

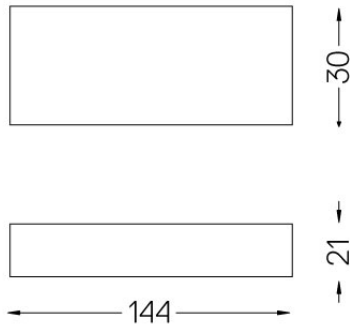

Driver DALI [1 luminaire]

59102



Driver DALI for Go ø75 [100mA]  
230Vac | 50/60Hz | Class II

Weight  
**0,08Kg**

Finishes  
**.99**

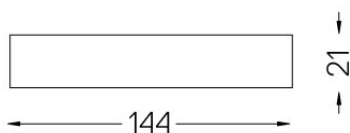
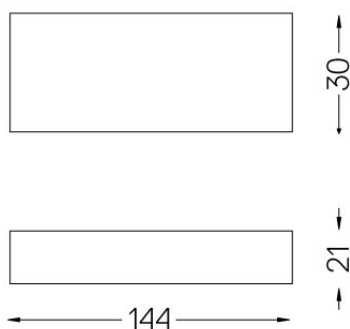

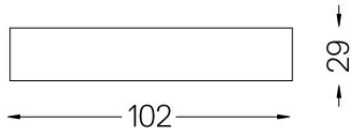
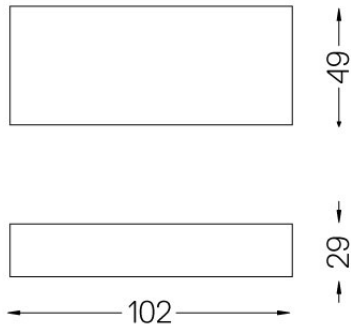

## Go IP65 Square

Driver PhaseCut [1 luminaire]

59105

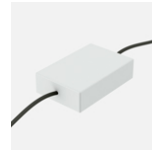

Driver PhaseCut for Go ø75  
[180mA]  
230Vac | 50/60Hz | Class II

Weight  
0,13Kg

Finishes  
.99



## Go IP65 Square

Driver PhaseCut [1 luminaire]

59104

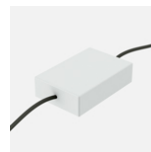

Driver PhaseCut for Go ø75  
[100mA]  
230Vac | 50/60Hz | Class II

Weight  
0,07Kg

Finishes  
.99

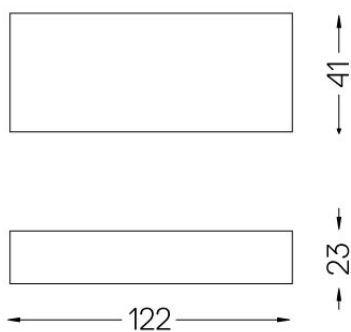





## Go IP65 Square

Driver 1-10V [1 luminaire]

59107

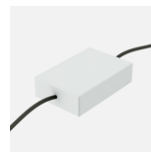

Driver 1-10V for Go ø75 [200mA]  
230Vac | 50/60Hz | Class II

Weight  
0,07Kg

Finishes  
.99

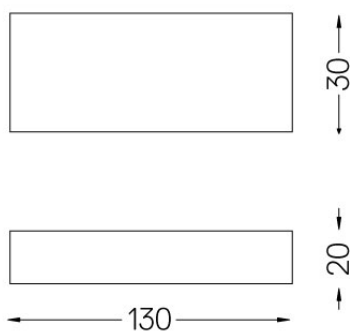



## Go IP65 Square

Driver 1-10V [1 luminaire]

59106



Driver 1-10V for Go ø75 [120mA]  
230Vac | 50/60Hz | Class II

Weight  
0,07Kg

Finishes  
.99

