

3,7W / 310lm / 3500K / Medium 26° /
50x50mm

64866



Design: O/M

Ceiling-recessed luminaire made of aluminium die-cast.

Recessing system with spring clips.

LED CRI>90 / >50.000h, L80/B10
3-step MacAdam / Power supply not included
IP65 | 100mA



LED	3500K	Light Source	Luminaire
Power	3,7W	3,7W	3,7W
Flux	410lm	310lm	310lm
Efficiency	111lm/W	84lm/W	84lm/W
LOR	-	-	76%
UGR	-	-	<10

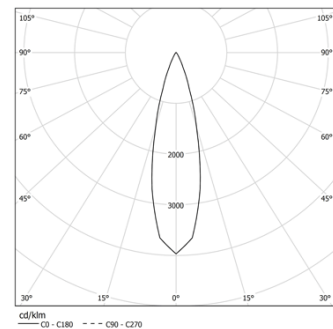

Beam angle
Medium 26°

Application



Weight
0.08Kg



45x45

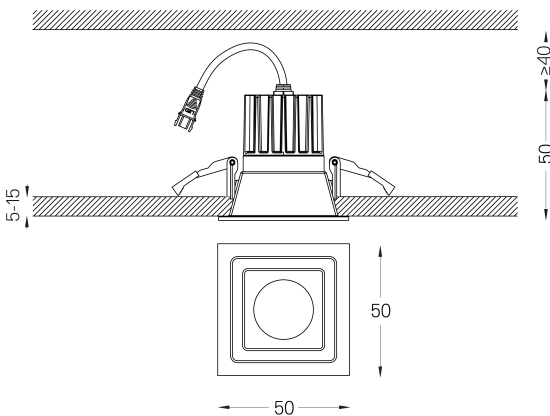

Finishes

- .04 Matt White
- .05 Matt Black

Mandatory

- 59088 Driver On/Off [100mA]
138x30x21mm
- 59089 Driver DALI [100mA]
144x30x21mm
- 59090 Driver PhaseCut [100mA]
122x41x23mm
- 59091 Driver 1-10V [100mA]
130x30x20mm

The cutout dimensions are for plasterboard ceilings. For other type of material please contact: support@om-light.com

Data according to regulations

2019/2020/EU supplemented by 2021/341 | 2019/2015/EU supplemented by 2021/340/EU Energy Consumption Labelling Ordinance. This product contains a light source of efficiency class F Model Identifier BXRH-35G1000-B-83