

3,7W / 285lm / 2700K / Medium 26° /
50x50mm

64860



Design: O/M

Ceiling-recessed luminaire made of aluminium die-cast.

Recessing system with spring clips.

LED CRI>90 / >50.000h, L80/B10
3-step MacAdam / Power supply not included
IP65 | 100mA



LED	2700K	Light Source	Luminaire
Power		3,7W	3,7W
Flux		375lm	285lm
Efficiency		101lm/W	77lm/W
LOR		-	76%
UGR		-	<10

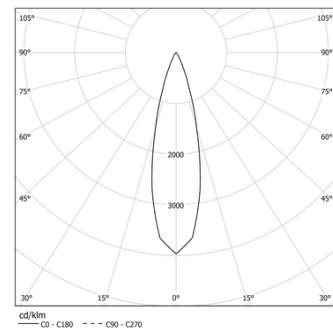

Beam angle
Medium 26°

Application



Weight
0.08Kg

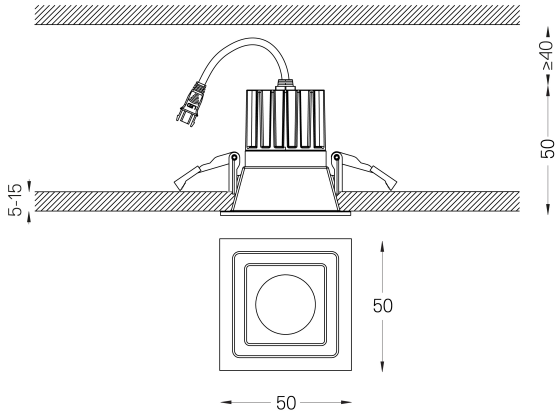

Finishes

- .04 Matt White
- .05 Matt Black

Mandatory

- 59088** Driver On/Off [100mA]
138x30x21mm
- 59089** Driver DALI [100mA]
144x30x21mm
- 59090** Driver PhaseCut [100mA]
122x41x23mm
- 59091** Driver 1-10V [100mA]
130x30x20mm

Optional

- 59140** Flush accessory (12.5mm ceilings)
110X56X16,5mm
- 59141** Flush accessory (15mm ceilings)
110X56X19,5mm
- 59150** Frosted Glass
ø28x2mm

The cutout dimensions are for plasterboard ceilings. For other type of material please contact: support@om-light.com

Data according to regulations

2019/2020/EU supplemented by 2021/341 | 2019/2015/EU supplemented by 2021/340/EU Energy Consumption Labelling Ordinance. This product contains a light source of efficiency class F Model Identifier BXRH-27G1000-B-83