

6,7W / 3,4W / 550lm / 280lm / 4000K /
On/Off / Asymmetric / ø75mm

64847



Design: O/M

Ceiling-recessed luminaire made of aluminium die-cast.

Recessing system with spring clips.

LED CRI>90 / >50.000h, L80/B10
3-step MacAdam / Power supply not included
IP65 | 200mA / 100mA



LED	4000K	Light Source	Luminaire
Power		6,7W / 3,4W	6,7W / 3,4W
Flux		1065lm / 535lm	550lm / 280lm
Efficiency		165lm/W	82lm/W
LOR		-	50%
UGR		-	-

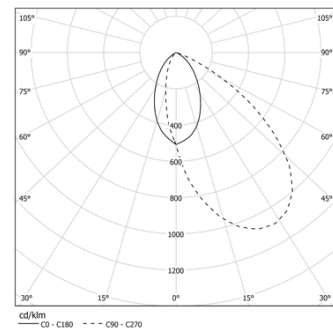

Beam angle
Asymmetric

Application



Weight
0.21Kg

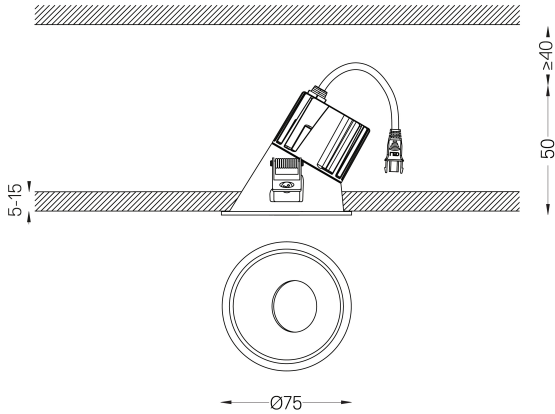

Finishes

- .04 Matt White
- .05 Matt Black

Mandatory

- 59101** Driver On/Off [200mA]
147x43x30mm
- 59100** Driver On/Off [100mA]
110x40x21mm
- 59103** Driver DALI [200mA]
144x30x21mm
- 59102** Driver DALI [100mA]
144x30x21mm
- 59105** Driver PhaseCut [180mA]
102x49x29mm
- 59104** Driver PhaseCut [100mA]
122x41x23mm
- 59107** Driver 1-10V [200mA]
130x30x20mm
- 59106** Driver 1-10V [120mA]
130x30x20mm

Optional

- 59069** Flush accessory (12.5mm ceilings)
176x17mm

The cutout dimensions are for plasterboard ceilings. For other type of material please contact: support@om-light.com

The 5-year guarantee applies only when the luminaire and driver are supplied together.

Data according to regulations

2019/2020/EU supplemented by 2021/341 | 2019/2015/EU supplemented by 2021/340/EU Energy Consumption Labelling Ordinance. This product contains a light source of efficiency class E Model Identifier BXRE-40G10FB-C-83



Go IP65 Asymmetric

Driver On/Off [1 luminaire]

59101

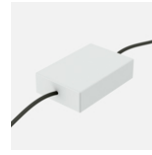

Driver On/Off for Go ø75
[200mA]
230Vac | 50/60Hz | Class II

Weight
0,08Kg

Finishes
.99

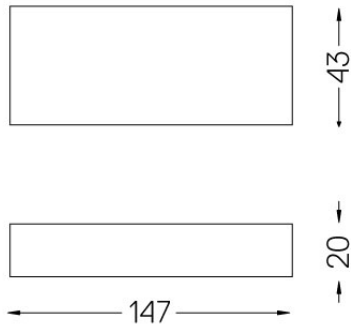



Go IP65 Asymmetric

Driver On/Off [1 luminaire]

59100



Driver On/Off for Go ø75 [100mA]
230Vac | 50/60Hz | Class II

Weight
0,09Kg

Finishes
.99

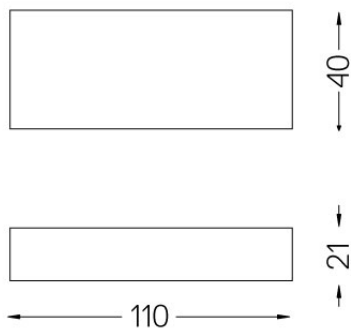

Driver DALI [1 luminaire]

59103

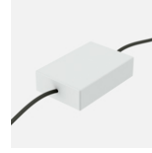

Driver DALI for Go ø75 [200mA]
230Vac | 50/60Hz | Class II

Weight
0,08Kg

Finishes
.99

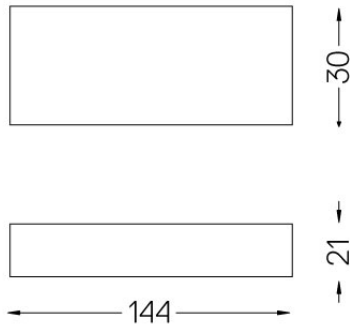

Driver DALI [1 luminaire]

59102



Driver DALI for Go ø75 [100mA]
230Vac | 50/60Hz | Class II

Weight
0,08Kg

Finishes
.99

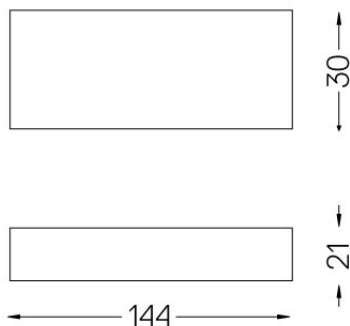



Go IP65 Asymmetric

Driver PhaseCut [1 luminaire]

59105

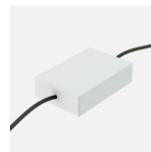

Driver PhaseCut for Go ø75
[180mA]
230Vac | 50/60Hz | Class II

Weight
0,13Kg

Finishes
.99

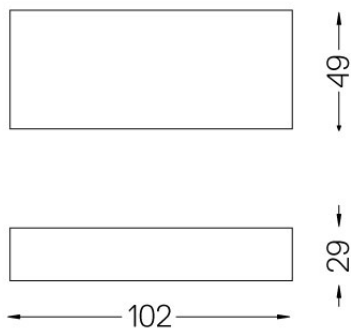



Go IP65 Asymmetric

Driver PhaseCut [1 luminaire]

59104

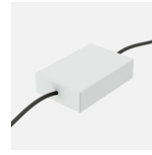

Driver PhaseCut for Go ø75
[100mA]
230Vac | 50/60Hz | Class II

Weight
0,07Kg

Finishes
.99

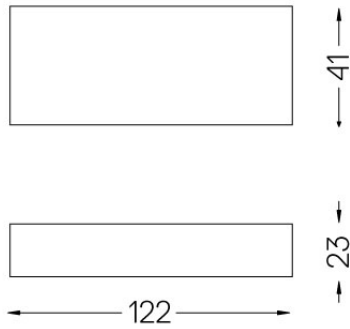

Driver 1-10V [1 luminaire]

59107

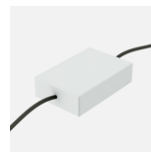

Driver 1-10V for Go ø75 [200mA]
230Vac | 50/60Hz | Class II

Weight
0,07Kg

Finishes
.99

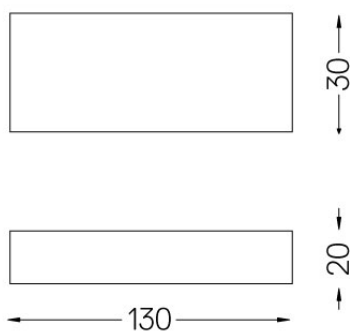

Driver 1-10V [1 luminaire]

59106



Driver 1-10V for Go ø75 [120mA]
230Vac | 50/60Hz | Class II

Weight
0,07Kg

Finishes
.99

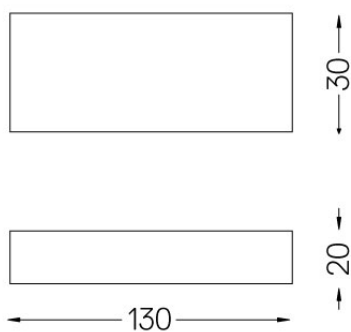

Go IP65 Asymmetric

Flush accessory (12.5mm
ceilings)

59069

1 mm

Ø88



Flush accessory Go
For 12.5mm ceilings.

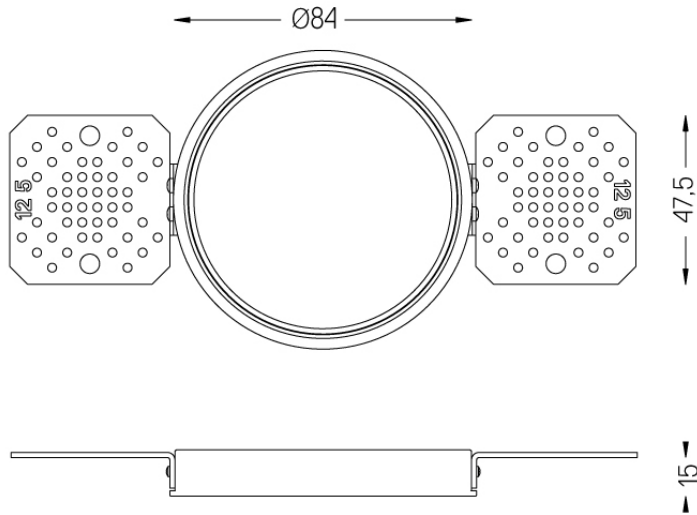

Weight
0,11Kg

Finishes
.99