

6,7W / 3,4W / 545lm / 275lm / 3500K /  
Asymmetric / ø75mm

64843



Design: O/M

Ceiling-recessed luminaire made of aluminium die-cast.

Recessing system with spring clips.

LED CRI>90 / >50.000h, L80/B10  
3-step MacAdam / Power supply not included  
IP65 | 200mA / 100mA



LED	3500K	Light Source	Luminaire
Power		6,7W / 3,4W	6,7W / 3,4W
Flux		1055lm / 530lm	545lm / 275lm
Efficiency		163lm/W	81lm/W
LOR		-	50%
UGR		-	-

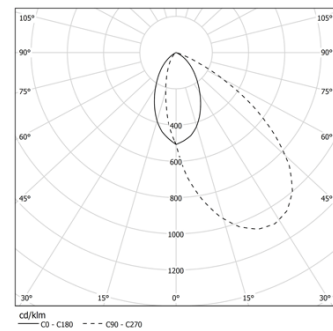

Beam angle  
Asymmetric

Application



Weight  
0.21Kg

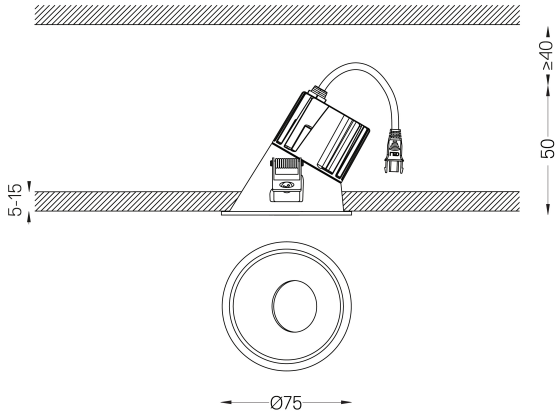

## Finishes

- .04 Matt White
- .05 Matt Black

## Mandatory

- 59101** Driver On/Off [200mA]  
147x43x30mm
- 59100** Driver On/Off [100mA]  
110x40x21mm
- 59103** Driver DALI [200mA]  
144x30x21mm
- 59102** Driver DALI [100mA]  
144x30x21mm
- 59105** Driver PhaseCut [180mA]  
102x49x29mm
- 59104** Driver PhaseCut [100mA]  
122x41x23mm
- 59107** Driver 1-10V [200mA]  
130x30x20mm
- 59106** Driver 1-10V [120mA]  
130x30x20mm

## Optional

- 59134** Flush accessory (12.5mm ceilings)  
140x82x16,5mm
- 59135** Flush accessory (15mm ceilings)  
140x82x19,5mm

The cutout dimensions are for plasterboard ceilings. For other type of material please contact: [support@om-light.com](mailto:support@om-light.com)

The 5-year guarantee applies only when the luminaire and driver are supplied together.

## Data according to regulations

2019/2020/EU supplemented by 2021/341 | 2019/2015/EU supplemented by 2021/340/EU Energy Consumption Labelling Ordinance. This product contains a light source of efficiency class E Model Identifier BXRE-35G10FB-C-83