

6,7W / 3,4W / 800lm / 400lm / 3000K / Flood  
48° / ø75mm

64838



Design: O/M

Ceiling-recessed luminaire made of aluminium die-cast.

Recessing system with spring clips.

Recessing accessory for flush version supplied separately.

LED CRI>90 / >50.000h, L80/B10  
3-step MacAdam / Power supply not included  
IP65 | 200mA / 100mA



LED	3000K	Light Source	Luminaire
Power		6,7W / 3,4W	6,7W / 3,4W
Flux		1055lm / 530lm	800lm / 400lm
Efficiency		157lm/W	119lm/W
LOR		-	76%
UGR		-	<19

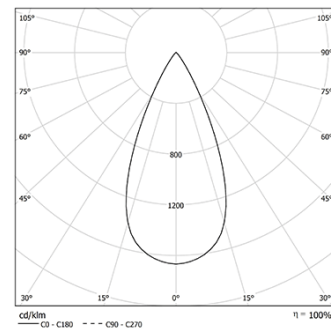

Beam angle  
Flood 48°

Application



Weight  
0.21Kg

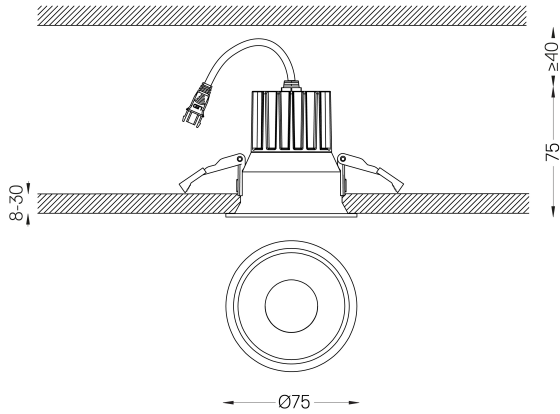

## Finishes

- .04 Matt White
- .05 Matt Black

## Mandatory

**59101** Driver On/Off [200mA]

147x43x30mm

**59100** Driver On/Off [100mA]

110x40x21mm

**59103** Driver DALI [200mA]

144x30x21mm

**59102** Driver DALI [100mA]

144x30x21mm

**59105** Driver PhaseCut [180mA]

102x49x29mm

**59104** Driver PhaseCut [100mA]

122x41x23mm

**59107** Driver 1-10V [200mA]

130x30x20mm

**59106** Driver 1-10V [120mA]

130x30x20mm

## Optional

**59069** Flush accessory (12.5mm ceilings)

176x17mm

**59070** Flush accessory (15mm ceilings)

176x19,5mm

**59071** Flush accessory (25mm ceilings)

176x29,5mm

The cutout dimensions are for plasterboard ceilings. For other type of material please contact: [support@om-light.com](mailto:support@om-light.com)

The 5-year guarantee applies only when the luminaire and driver are supplied together.

## Data according to regulations

2019/2020/EU supplemented by 2021/341 | 2019/2015/EU supplemented by 2021/340/EU Energy Consumption Labelling Ordinance. This product contains a light source of efficiency class E  
Model Identifier BXRE-30G10FB-C-83