

6,7W / 3,4W / 800lm / 400lm / 3000K /
Medium 34° / ø75mm

64837



Design: O/M

Ceiling-recessed luminaire made of aluminium die-cast.

Recessing system with spring clips.

Recessing accessory for flush version supplied separately.

LED CRI>90 / >50.000h, L80/B10
3-step MacAdam / Power supply not included
IP65 | 200mA / 100mA



LED	3000K	Light Source	Luminaire
Power		6,7W / 3,4W	6,7W / 3,4W
Flux		1055lm / 530lm	800lm / 400lm
Efficiency		157lm/W	119lm/W
LOR		-	76%
UGR		-	<16

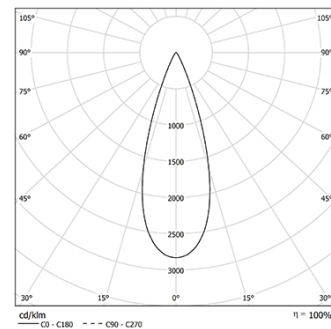

Beam angle
Medium 34°

Application



Weight
0.21Kg

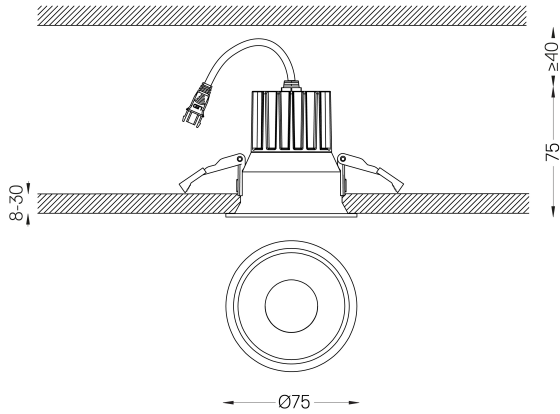

Finishes

- .04 Matt White
- .05 Matt Black

Mandatory

59101 Driver On/Off [200mA]

147x43x30mm

59100 Driver On/Off [100mA]

110x40x21mm

59103 Driver DALI [200mA]

144x30x21mm

59102 Driver DALI [100mA]

144x30x21mm

59105 Driver PhaseCut [180mA]

102x49x29mm

59104 Driver PhaseCut [100mA]

122x41x23mm

59107 Driver 1-10V [200mA]

130x30x20mm

59106 Driver 1-10V [120mA]

130x30x20mm

Optional

59069 Flush accessory (12.5mm ceilings)

176x17mm

59070 Flush accessory (15mm ceilings)

176x19,5mm

59071 Flush accessory (25mm ceilings)

176x29,5mm

The cutout dimensions are for plasterboard ceilings. For other type of material please contact: support@om-light.com

The 5-year guarantee applies only when the luminaire and driver are supplied together.

Data according to regulations

2019/2020/EU supplemented by 2021/341 | 2019/2015/EU supplemented by 2021/340/EU Energy Consumption Labelling Ordinance. This product contains a light source of efficiency class E
Model Identifier BXRE-30G10FB-C-83