

3,7W / 315lm / 4000K / Medium 26° /  
ø50mm

64829



Design: O/M

Ceiling-recessed luminaire made of aluminium die-cast.

Recessing system with spring clips.

LED CRI>90 / >50.000h, L80/B10  
3-step MacAdam / Power supply not included  
IP65 | 100mA



LED	4000K	Light Source	Luminaire
Power		3,7W	3,7W
Flux		415lm	315lm
Efficiency		112lm/W	85lm/W
LOR		-	76%
UGR		-	<10

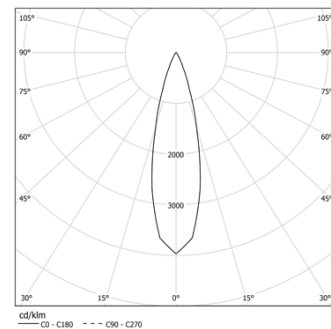

Beam angle  
Medium 26°

Application



Weight  
0.08Kg



Ø45

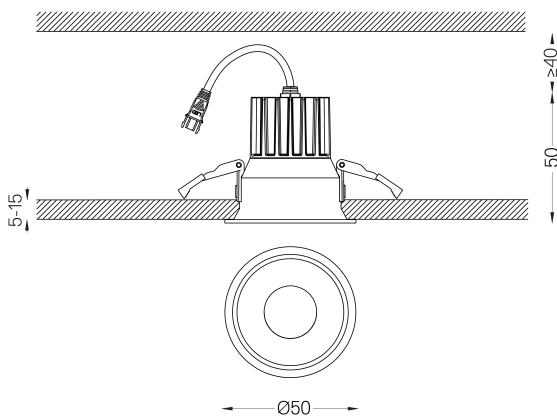

Finishes

- .04 Matt White
- .05 Matt Black

Mandatory

- 59088 Driver On/Off [100mA]  
138x30x21mm
- 59089 Driver DALI [100mA]  
144x30x21mm
- 59090 Driver PhaseCut [100mA]  
122x41x23mm
- 59091 Driver 1-10V [120mA]  
130x30x20mm

The cutout dimensions are for plasterboard ceilings. For other type of material please contact: [support@om-light.com](mailto:support@om-light.com)

The 5-year guarantee applies only when the luminaire and driver are supplied together.

Data according to regulations

2019/2020/EU supplemented by 2021/341 | 2019/2015/EU supplemented by 2021/340/EU Energy Consumption Labelling Ordinance. This product contains a light source of efficiency class F Model Identifier BXRH-40G1000-B-83