

6,7W / 3,4W / 840lm / 420lm / 2700K /
On/Off / Medium 34° / 75x75mm

64809



Design: O/M

Ceiling-recessed luminaire made of aluminium die-cast.

Recessing system with spring clips.

LED CRI>90 / >50.000h, L80/B10
3-step MacAdam / Power supply not included
IP44 | 200mA / 100mA



LED	2700K	Light Source	Luminaire
Power		6,7W / 3,4W	6,7W / 3,4W
Flux		1035lm / 520lm	840lm / 420lm
Efficiency		154lm/W	125lm/W
LOR		-	81%
UGR		-	<16

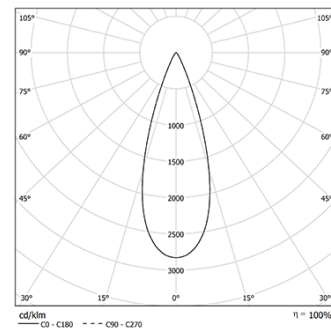

Beam angle
Medium 34°

Application



Weight
0.21Kg

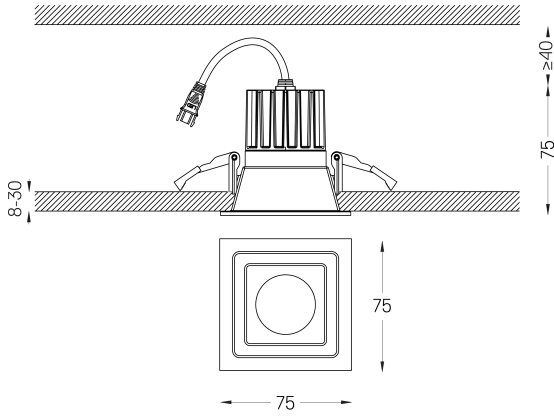

Finishes

- .04 Matt White
- .05 Matt Black

Mandatory

59101 Driver On/Off [200mA]

147x43x30mm

59100 Driver On/Off [100mA]

110x40x21mm

59103 Driver DALI [200mA]

144x30x21mm

59102 Driver DALI [100mA]

144x30x21mm

59105 Driver PhaseCut [180mA]

102x49x29mm

59104 Driver PhaseCut [100mA]

122x41x23mm

59107 Driver 1-10V [200mA]

130x30x20mm

59106 Driver 1-10V [120mA]

130x30x20mm

The cutout dimensions are for plasterboard ceilings. For other type of material please contact: support@om-light.com

The 5-year guarantee applies only when the luminaire and driver are supplied together.

Data according to regulations

2019/2020/EU supplemented by 2021/341 [2019/2015/EU

supplemented by 2021/340/EU Energy Consumption Labelling

Ordinance. This product contains a light source of efficiency class E

Model Identifier BXRE-27G10FB-C-83



Go Square

Driver On/Off [1 luminaire]

59101

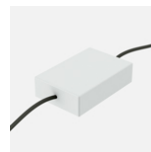

Driver On/Off for Go ø75
[200mA]
230Vac | 50/60Hz | Class II

Weight
0,08Kg

Finishes
.99

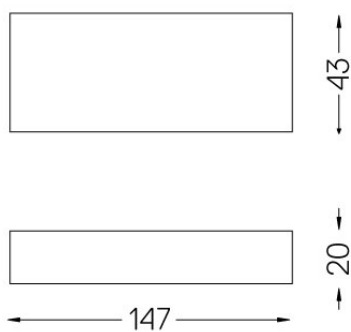



Go Square

Driver On/Off [1 luminaire]

59100

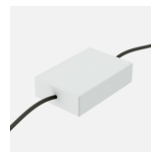

Driver On/Off for Go ø75 [100mA]
230Vac | 50/60Hz | Class II

Weight
0,09Kg

Finishes
.99

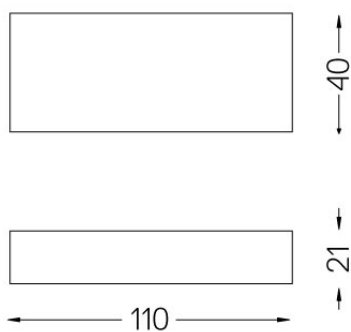



Driver DALI [1 luminaire]

59103

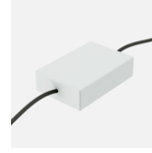

Driver DALI for Go ø75 [200mA]
230Vac | 50/60Hz | Class II

Weight
0,08Kg

Finishes
.99

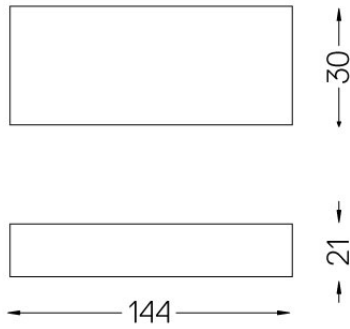



Driver DALI [1 luminaire]

59102

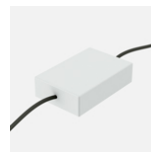

Driver DALI for Go ø75 [100mA]
230Vac | 50/60Hz | Class II

Weight
0,08Kg

Finishes
.99

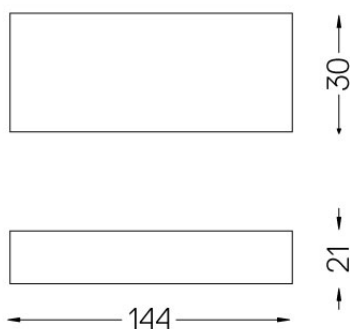

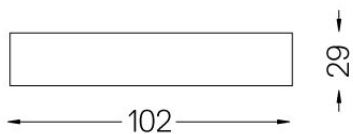
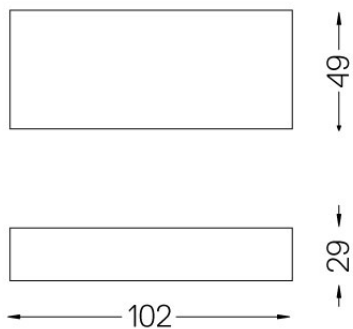

Go Square

Driver PhaseCut [1 luminaire]

59105

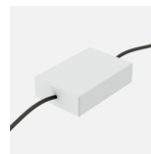

Driver PhaseCut for Go ø75
[180mA]
230Vac | 50/60Hz | Class II

Weight
0,13Kg

Finishes
.99

Driver PhaseCut [1 luminaire]

59104

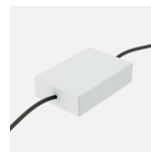

Driver PhaseCut for Go ø75
[100mA]
230Vac | 50/60Hz | Class II

Weight
0,07Kg

Finishes
.99

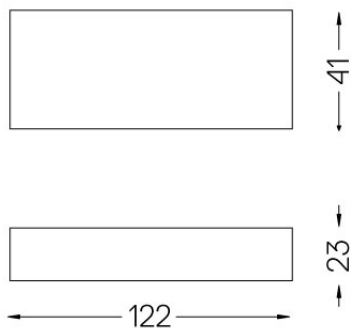



Driver 1-10V [1 luminaire]

59107

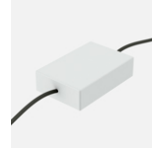

Driver 1-10V for Go ø75 [200mA]
230Vac | 50/60Hz | Class II

Weight
0,07Kg

Finishes
.99

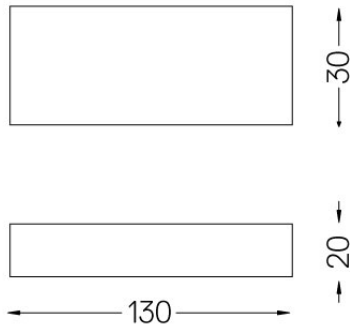



Go Square

Driver 1-10V [1 luminaire]

59106

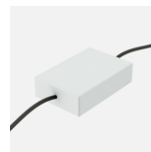

Driver 1-10V for Go ø75 [120mA]
230Vac | 50/60Hz | Class II

Weight
0,07Kg

Finishes
.99

