

6,7W / 3,7W / 530lm / 295lm / 2700K /  
On/Off / Spot 20° / 75x75mm

64808



Design: O/M

Ceiling-recessed luminaire made of aluminium die-cast.

Recessing system with spring clips.

LED CRI>90 / >50.000h, L80/B10  
3-step MacAdam / Power supply not included  
IP44 | 180mA / 100mA



LED	2700K	Light Source	Luminaire
Power		6,7W / 3,7W	6,7W / 3,7W
Flux		655lm / 365lm	530lm / 295lm
Efficiency		98lm/W	79lm/W
LOR		-	81%
UGR		-	<16

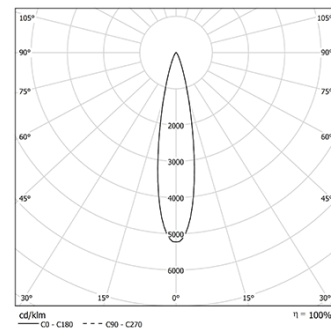

Beam angle  
Spot 20°

Application



Weight  
0.21Kg

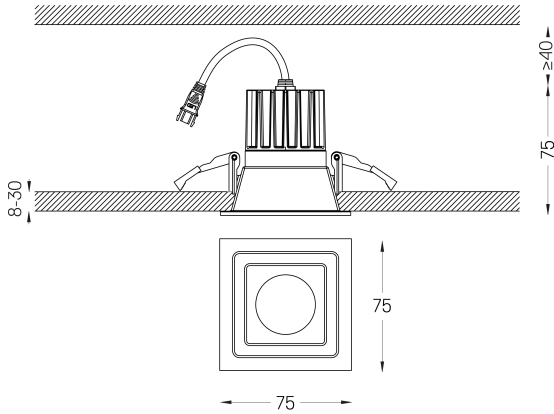

## Finishes

- .04 Matt White
- .05 Matt Black

## Mandatory

- 59093** Driver On/Off [180mA]  
147x43x30mm
- 59092** Driver On/Off [100mA]  
92x28x21mm
- 59095** Driver DALI [180mA]  
144x30x21mm
- 59094** Driver DALI [100mA]  
144x30x21mm
- 59097** Driver Phase-Cut [180mA]  
102x49x29mm
- 59096** Driver Phase-Cut [100mA]  
122x41x23mm
- 59099** Driver 1-10V [180mA]  
130x30x20mm
- 59098** Driver 1-10V [120mA]  
130x30x20mm

The cutout dimensions are for plasterboard ceilings. For other type of material please contact: [support@om-light.com](mailto:support@om-light.com)

The 5-year guarantee applies only when the luminaire and driver are supplied together.

## Data according to regulations

2019/2020/EU supplemented by 2021/341 | 2019/2015/EU  
supplemented by 2021/340/EU Energy Consumption Labelling  
Ordinance. This product contains a light source of efficiency class F  
Model Identifier BXRH-27G1000-B-83



## Go Square

Driver On/Off [1 luminaire]

59093



Driver On/Off for Go ø75 [180mA]  
230Vac | 50/60Hz | Class II

Weight  
**0,08Kg**

Finishes  
**.99**

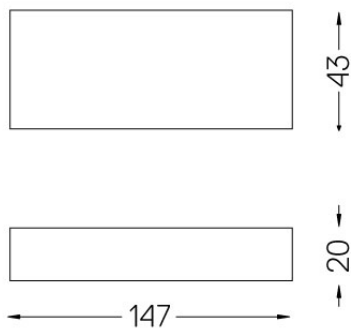



## Go Square

Driver On/Off [1 luminaire]

59092



Driver On/Off for Go ø75 [100mA]  
230Vac | 50/60Hz | Class II

Weight  
0,1Kg

Finishes  
.99

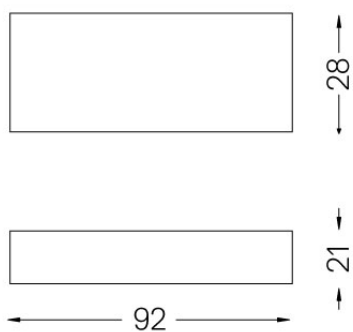



Driver DALI [1 luminaire]

59095



Driver DALI for Go ø75 [180mA]  
230Vac | 50/60Hz | Class II

Weight  
**0,08Kg**

Finishes  
**.99**

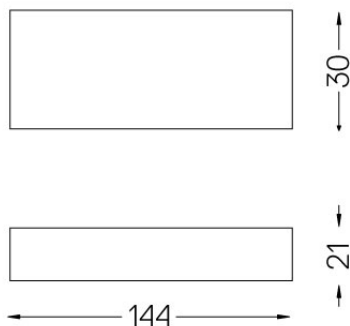



Driver DALI [1 luminaire]

59094

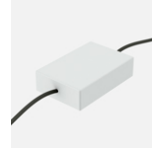

Driver DALI for Go ø75 [100mA]  
230Vac | 50/60Hz | Class II

Weight  
**0,08Kg**

Finishes  
**.99**

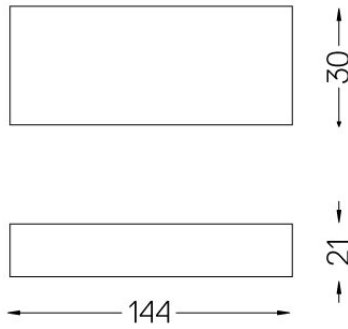

Driver PhaseCut [1 luminaire]

59097

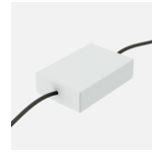

Driver PhaseCut for Go ø75  
[180mA]  
230Vac | 50/60Hz | Class II

Weight  
0,13Kg

Finishes  
.99

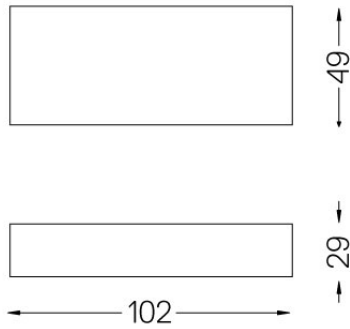



## Go Square

Driver PhaseCut [1 luminaire]

59096

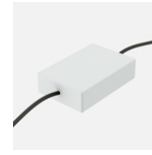

Driver PhaseCut for Go ø75  
[100mA]  
230Vac | 50/60Hz | Class II

Weight  
0,07Kg

Finishes  
.99

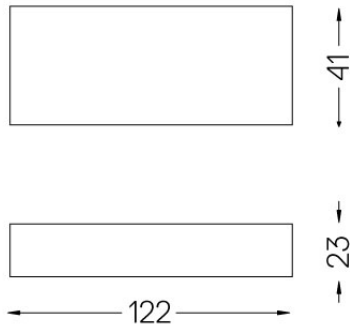





## Go Square

Driver 1-10V [1 luminaire]

59099

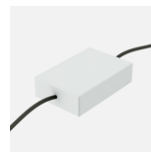

Driver 1-10V for Go ø75 [180mA]  
230Vac | 50/60Hz | Class II

Weight  
0,07Kg

Finishes  
.99

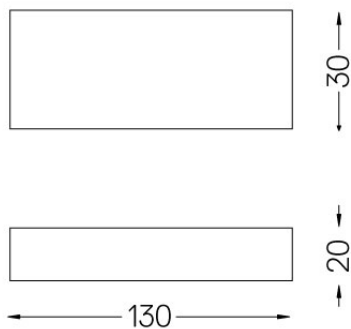



## Go Square

Driver 1-10V [1 luminaire]

59098



Driver 1-10V for Go ø75 [120mA]  
230Vac | 50/60Hz | Class II

Weight  
0,07Kg

Finishes  
.99

