

3,7W / 335lm / 4000K / Flood 60° / 50x50mm

64807



Design: O/M

Ceiling-recessed luminaire made of aluminium die-cast.

Recessing system with spring clips.

LED CRI>90 / >50.000h, L80/B10
3-step MacAdam / Power supply not included
IP44 | 100mA



LED	4000K	Light Source	Luminaire
Power		3,7W	3,7W
Flux		415lm	335lm
Efficiency		112lm/W	91lm/W
LOR		-	81%
UGR		-	<22

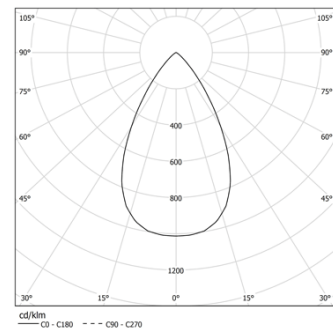

Beam angle
Flood 60°

Application



Weight
0.08Kg



45x45

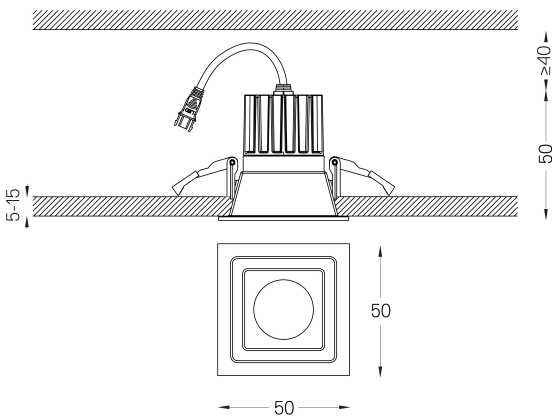

Finishes

- .04 Matt White
- .05 Matt Black

Mandatory

- 59088 Driver On/Off [100mA]
138x30x21mm
- 59089 Driver DALI [100mA]
144x30x21mm
- 59090 Driver PhaseCut [100mA]
122x41x23mm
- 59091 Driver 1-10V [120mA]
130x30x20mm

The cutout dimensions are for plasterboard ceilings. For other type of material please contact: support@om-light.com

The 5-year guarantee applies only when the luminaire and driver are supplied together.

Data according to regulations

2019/2020/EU supplemented by 2021/341 | 2019/2015/EU supplemented by 2021/340/EU Energy Consumption Labelling Ordinance. This product contains a light source of efficiency class F Model Identifier BXRH-40G1000-B-83