

3,7W / 300lm / 2700K / On/Off / Flood 42° / 50x50mm

64797



Design: O/M

Ceiling-recessed luminaire made of aluminium die-cast.

Recessing system with spring clips.

LED CRI>90 / >50.000h, L80/B10  
3-step MacAdam / Power supply not included  
IP44 | 100mA



LED	2700K	Light Source	Luminaire
Power	3,7W	3,7W	3,7W
Flux	375lm	300lm	300lm
Efficiency	101lm/W	81lm/W	81lm/W
LOR	-	-	80%
UGR	-	-	<16

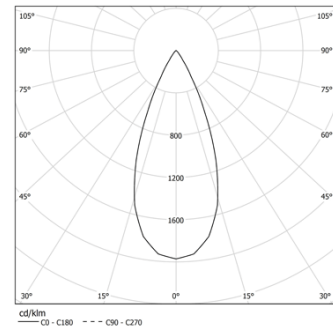

Beam angle  
Flood 42°

Application



Weight  
0.08Kg



45x45

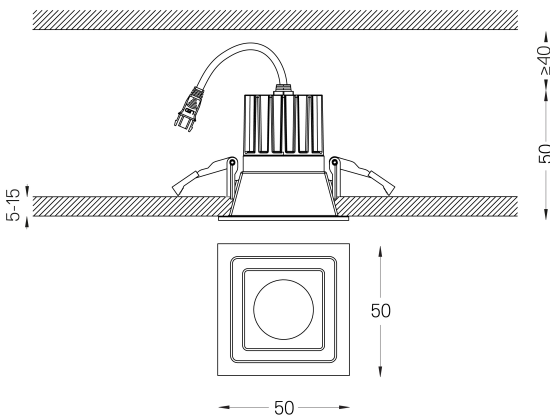

Finishes

- .04 Matt White
- .05 Matt Black

Mandatory

- 59088 Driver On/Off [100mA]  
138x30x21mm
- 59089 Driver DALI [100mA]  
144x30x21mm
- 59090 Driver PhaseCut [100mA]  
122x41x23mm
- 59091 Driver 1-10V [120mA]  
130x30x20mm

The cutout dimensions are for plasterboard ceilings. For other type of material please contact: [support@om-light.com](mailto:support@om-light.com)

The 5-year guarantee applies only when the luminaire and driver are supplied together.

Data according to regulations

2019/2020/EU supplemented by 2021/341 | 2019/2015/EU supplemented by 2021/340/EU Energy Consumption Labelling Ordinance. This product contains a light source of efficiency class F Model Identifier BXRH-27G1000-B-83



Driver DALI [1 luminaire]

59088

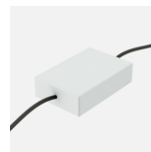

Driver On/Off for Go ø50 [100mA]  
230Vac | 50/60Hz | Class II

Weight  
0,1Kg

Finishes  
.99

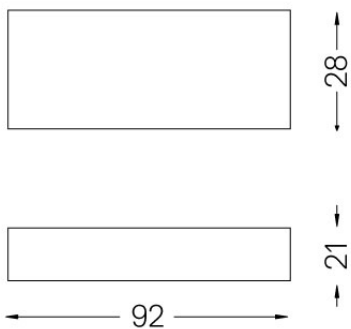



Driver DALI [1 luminaire]

59089

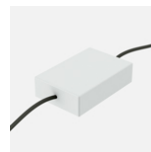

Driver DALI for Go ø50 [100mA]  
230Vac | 50/60Hz | Class II

Weight  
**0,06Kg**

Finishes  
**.99**

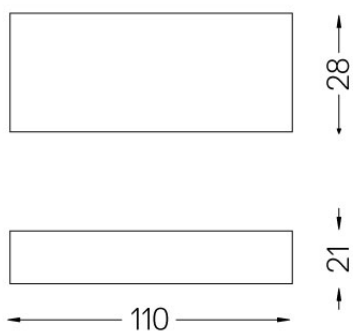



## Go Square

Driver PhaseCut [1 luminaire] **59090**

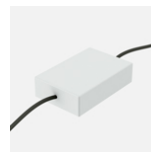

Driver PhaseCut for Go ø50  
[100mA]  
230Vac | 50/60Hz | Class II

Weight  
**0,08Kg**

Finishes  
**.99**

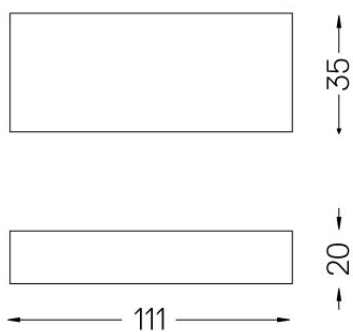



Driver 1-10V [1 luminaire]

59091

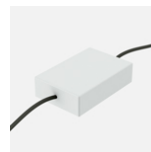

Driver 1-10V for Go ø50 [120mA]  
230Vac | 50/60Hz | Class II

Weight  
0,07Kg

Finishes  
.99

