

14W / 7W / 1845lm / 925lm / 3500K / Flood  
60° / ø100mm

64792



Design: O/M

Ceiling-recessed luminaire made of aluminium die-cast.

Recessing system with spring clips.

LED CRI>90 / >50.000h, L80/B10  
3-step MacAdam / Power supply not included  
IP44 | 400mA / 200mA



LED	3500K	Light Source	Luminaire
Power		14W / 7W	14W / 7W
Flux		2320lm / 1160lm	1845lm / 925lm
Efficiency		165lm/W	132lm/W
LOR		-	80%
UGR		-	<22

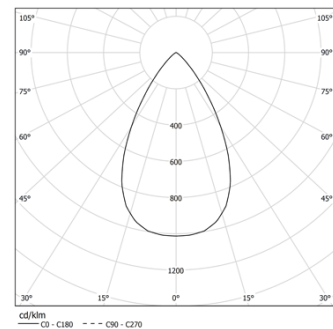

Beam angle  
Flood 60°

Application



Weight  
0.37Kg

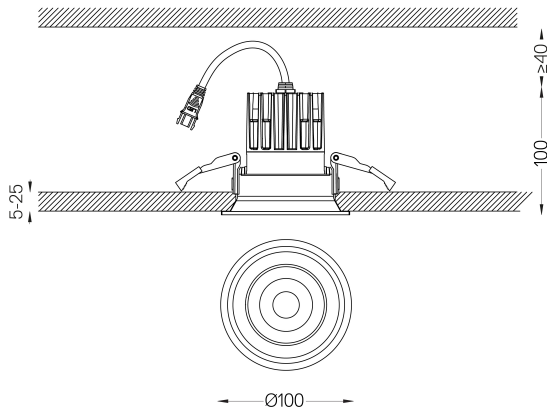

## Finishes

- .04 Matt White
- .05 Matt Black

## Mandatory

- 59117** Driver On/Off [400mA]  
147x43x30mm
- 59116** Driver On/Off [200mA]  
147x43x30mm
- 59119** Driver DALI [400mA]  
144x30x21mm
- 59118** Driver DALI [200mA]  
144x30x21mm
- 59121** Driver PhaseCut [400mA]  
111x22x52mm
- 59120** Driver PhaseCut [180mA]  
102x49x29mm
- 59123** Driver 1-10V [400mA]  
163x30x21mm
- 59122** Driver 1-10V [200mA]  
130x30x20mm

The cutout dimensions are for plasterboard ceilings. For other type of material please contact: [support@om-light.com](mailto:support@om-light.com)

The 5-year guarantee applies only when the luminaire and driver are supplied together.

## Data according to regulations

2019/2020/EU supplemented by 2021/341 | 2019/2015/EU  
supplemented by 2021/340/EU Energy Consumption Labelling  
Ordinance. This product contains a light source of efficiency class E  
Model Identifier BXRE-35G20FB-C-83