

10W / 5W / 1215lm / 610lm / 3500K / Spot
20° / ø100mm

64790



Design: O/M

Ceiling-recessed luminaire made of aluminium die-cast.

Recessing system with spring clips.

LED CRI>90 / >50.000h, L80/B10
3-step MacAdam / Power supply not included
IP44 | 300mA / 150mA



LED	3500K	Light Source	Luminaire
Power		10W / 5W	10W / 5W
Flux		1540lm / 770lm	1215lm / 610lm
Efficiency		154lm/W	122lm/W
LOR		-	79%
UGR		-	<10

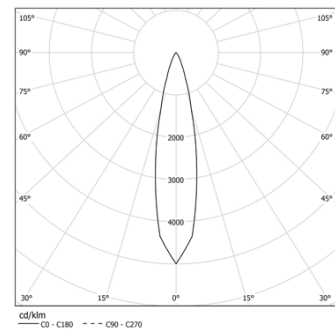

Beam angle
Spot 20°

Application



Weight
0.37Kg

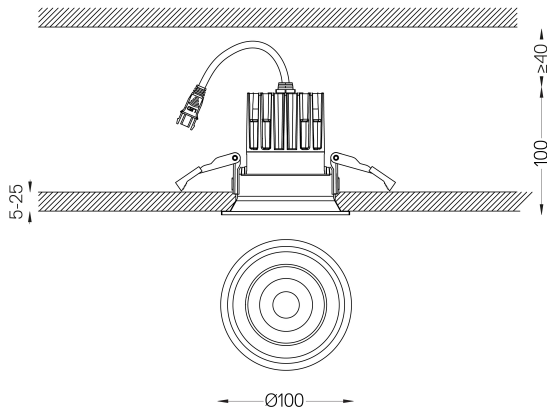

Finishes

- .04 Matt White
- .05 Matt Black

Mandatory

- 59109** Driver On/Off [300mA]
147x43x30mm
- 59108** Driver On/Off [150mA]
147x43x30mm
- 59111** Driver DALI [300mA]
144x30x21mm
- 59110** Driver DALI [150mA]
144x30x21mm
- 59113** Driver PhaseCut [300mA]
102x51x30mm
- 59112** Driver PhaseCut [150mA]
102x49x29mm
- 59115** Driver 1-10V [300mA]
130x30x20mm
- 59114** Driver 1-10V [150mA]
130x30x20mm

The cutout dimensions are for plasterboard ceilings. For other type of material please contact: support@om-light.com

The 5-year guarantee applies only when the luminaire and driver are supplied together.

Data according to regulations

2019/2020/EU supplemented by 2021/341 | 2019/2015/EU
supplemented by 2021/340/EU Energy Consumption Labelling
Ordinance. This product contains a light source of efficiency class E
Model Identifier BXRE-35G10FB-C-83