

6,7W / 3,7W / 585lm / 330lm / 4000K / Spot
20° / ø75mm

64781



Design: O/M

Ceiling-recessed luminaire made of aluminium die-cast.

Recessing system with spring clips.

Recessing accessory for flush version supplied separately.

LED CRI>90 / >50.000h, L80/B10
3-step MacAdam / Power supply not included
IP44 | 180mA / 100mA



LED	4000K	Light Source	Luminaire
Power		6,7W / 3,7W	6,7W / 3,7W
Flux		720lm / 400lm	585lm / 330lm
Efficiency		107lm/W	87lm/W
LOR		-	81%
UGR		-	<16

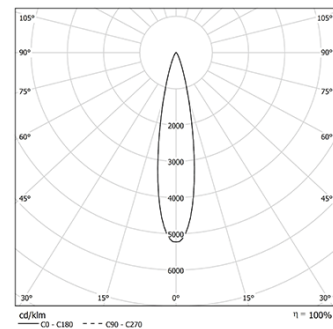

Beam angle
Spot 20°

Application



Weight
0.21Kg

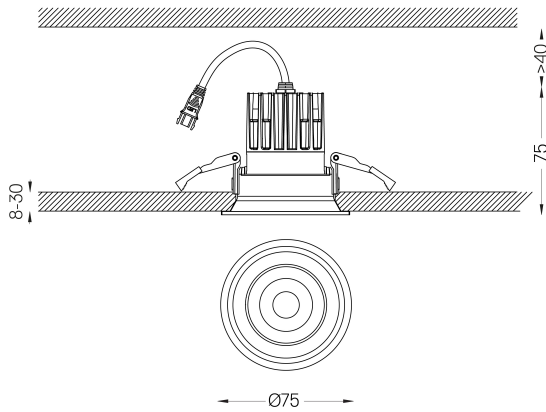

Finishes

- .04 Matt White
- .05 Matt Black

Mandatory

- 59093** Driver On/Off [180mA]
147x43x30mm
- 59092** Driver On/Off [100mA]
92x28x21mm
- 59095** Driver DALI [180mA]
144x30x21mm
- 59094** Driver DALI [100mA]
144x30x21mm
- 59097** Driver Phase-Cut [180mA]
102x49x29mm
- 59096** Driver Phase-Cut [100mA]
122x41x23mm
- 59099** Driver 1-10V [180mA]
130x30x20mm
- 59098** Driver 1-10V [120mA]
130x30x20mm

Optional

- 59069** Flush accessory (12.5mm ceilings)
176x17mm
- 59070** Flush accessory (15mm ceilings)
176x19,5mm
- 59071** Flush accessory (25mm ceilings)
176x29,5mm

The cutout dimensions are for plasterboard ceilings. For other type of material please contact: support@om-light.com

The 5-year guarantee applies only when the luminaire and driver are supplied together.

Data according to regulations

2019/2020/EU supplemented by 2021/341 | 2019/2015/EU supplemented by 2021/340/EU Energy Consumption Labelling Ordinance. This product contains a light source of efficiency class F
Model Identifier BXRH-40G1000-B-83