

6,7W / 3,4W / 840lm / 420lm / 2700K /
Medium 34° / ø75mm

64773



Design: O/M

Ceiling-recessed luminaire made of aluminium die-cast.

Recessing system with spring clips.

Recessing accessory for flush version supplied separately.

LED CRI>90 / >50.000h, L80/B10
3-step MacAdam / Power supply not included
IP44 | 200mA / 100mA



LED	2700K	Light Source	Luminaire
Power		6,7W / 3,4W	6,7W / 3,4W
Flux		1035lm / 520lm	840lm / 420lm
Efficiency		154lm/W	125lm/W
LOR		-	81%
UGR		-	<16

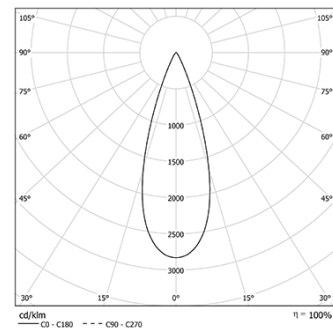

Beam angle
Medium 34°

Application



Weight
0.21Kg

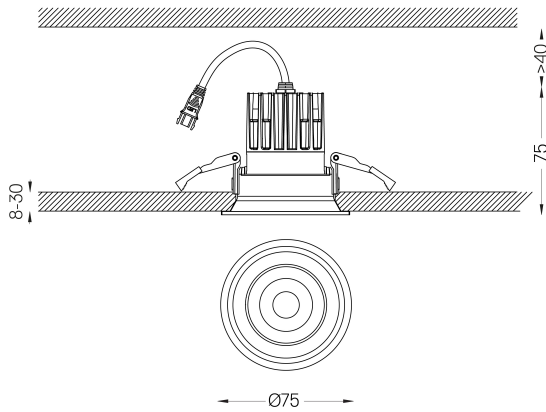

Finishes

- .04 Matt White
- .05 Matt Black

Mandatory

- 59101** Driver On/Off [200mA]
147x43x30mm
- 59100** Driver On/Off [100mA]
110x40x21mm
- 59103** Driver DALI [200mA]
144x30x21mm
- 59102** Driver DALI [100mA]
144x30x21mm
- 59105** Driver PhaseCut [180mA]
102x49x29mm
- 59104** Driver PhaseCut [100mA]
122x41x23mm
- 59107** Driver 1-10V [200mA]
130x30x20mm
- 59106** Driver 1-10V [120mA]
130x30x20mm

Optional

- 59069** Flush accessory (12.5mm ceilings)
176x17mm
- 59070** Flush accessory (15mm ceilings)
176x19,5mm
- 59071** Flush accessory (25mm ceilings)
176x29,5mm

The cutout dimensions are for plasterboard ceilings. For other type of material please contact: support@om-light.com

The 5-year guarantee applies only when the luminaire and driver are supplied together.

Data according to regulations

2019/2020/EU supplemented by 2021/341 | 2019/2015/EU supplemented by 2021/340/EU Energy Consumption Labelling Ordinance. This product contains a light source of efficiency class E
Model Identifier BXRE-27G10FB-C-83