



Design: O/M

Ceiling-recessed luminaire made of aluminium die-cast.

Recessing system with spring clips.

LED CRI>90 / >50.000h, L80/B10  
3-step MacAdam / Power supply not included  
IP44 | 100mA



LED	3500K	Light Source	Luminaire
Power		3,7W	3,7W
Flux		410lm	330lm
Efficiency		111lm/W	89lm/W
LOR		-	80%
UGR		-	<16

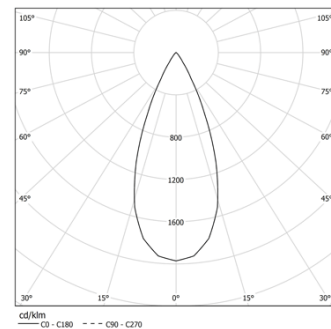

Beam angle  
Flood 42°

Application



Weight  
0.08Kg

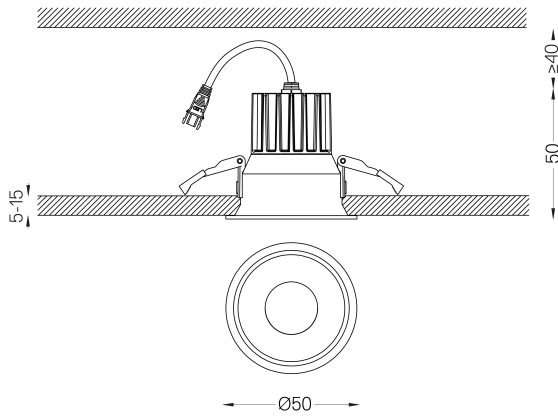

## Finishes

- .04 Matt White
- .05 Matt Black

## Mandatory

- 59088** Driver On/Off [100mA]  
138x30x21mm
- 59089** Driver DALI [100mA]  
144x30x21mm
- 59090** Driver PhaseCut [100mA]  
122x41x23mm
- 59091** Driver 1-10V [120mA]  
130x30x20mm

## Optional

- 59132** Flush accessory (12.5mm ceilings)  
110x57x16,5mm
- 59133** Flush accessory (15mm ceilings)  
110x57x19,5mm
- 59148** Louvre  
ø25x4mm
- 59149** Elliptical diffuser  
ø25x4mm

The cutout dimensions are for plasterboard ceilings. For other type of material please contact: [support@om-light.com](mailto:support@om-light.com)

The 5-year guarantee applies only when the luminaire and driver are supplied together.

## Data according to regulations

2019/2020/EU supplemented by 2021/341 | 2019/2015/EU supplemented by 2021/340/EU Energy Consumption Labelling Ordinance. This product contains a light source of efficiency class F  
Model Identifier BXRH-35G1000-B-83