



Design: O/M + Eduardo Souto de Moura
Outdoor luminaire in aluminium body with anti-corrosion treatment and textured electrostatic 100% polyester paint finish.
Clear glass diffuser.
Asymmetrical aluminium reflector with 97% reflection, low luminance level and low UGR level.
Fitting accessory available separately.

*Polycarbonate clear diffuser (IK10) available under request.

LED CRI>90 / >50.000h, L80/B10
2-step MacAdam / power supply included.
IP66 | 230Vac | 50/60Hz



LED	2700K	Light Source	Luminaire
Power		7,3W	9,1W
Flux		700lm	370lm
Efficiency		96lm/W	41lm/W
LOR		-	53%
UGR		-	-

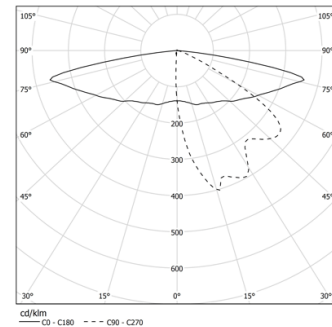

Beam angle
Elliptical
longitudinal

Application



Weight
7,2Kg

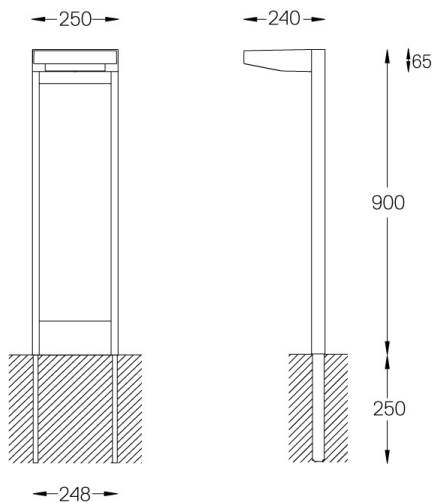

Finishes

- .01 White / RAL 9010
- .02 Black / RAL 9005
- .33 Graphite Black
- .34 Rust

Optional

59082 Assembly accessory

For the specific supply of "DALI 2" drivers, please contact:
support@om-light.com