



Design: O/M + Eduardo Souto de Moura

Outdoor luminaire in aluminium body with anti-corrosion treatment and textured electrostatic 100% polyester paint finish.

Clear glass diffuser.

Asymmetrical aluminium reflector with 97% reflection, low luminance level and low UGR level.

Fitting accessory available separately.

\*Polycarbonate clear diffuser (IK10) available under request.

LED CRI>90 / >50.000h, L80/B10  
2-step MacAdam / power supply included.  
IP66 | 230Vac | 50/60Hz



LED	2700K	Light Source	Luminaire
Power		6,2W	7,8W
Flux		670lm	240lm
Efficiency		108lm/W	31lm/W
LOR		-	36%
UGR		-	-

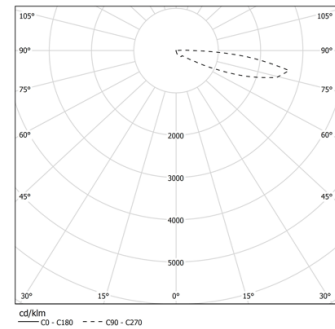

Beam angle  
Elliptical  
transverse

Application



Weight  
7,2Kg

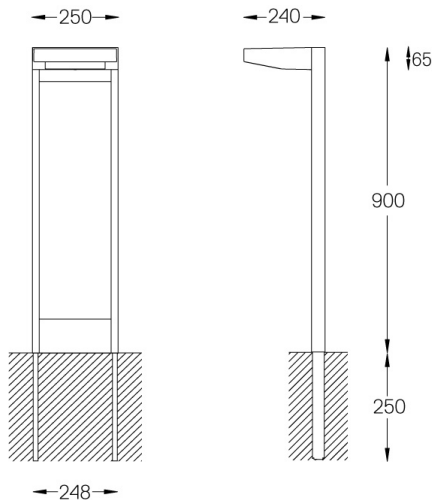

Finishes

- .01 White / RAL 9010
- .02 Black / RAL 9005
- .33 Graphite Black
- .34 Rust

Optional

59082 Assembly accessory