

32+63W / 1650+3300lm / 4000K / On/Off /  
Diffuse Direct/ Indirect / 1411mm

64181



Design: Eduardo Souto de Moura  
MGB Pendant Indirect module with housing made of aluminium profile with 25micron maximum corrosion resistance anodization with textured electrostatic 100% polyester paint.

Frosted acrylic diffuser with user friendly clipping system.

Steel end caps with textured electrostatic 100% polyester paint.

Frosted acrylic diffuser for direct light and indirect light.

Fitting accessories supplied separately.

LED CRI>80 / >50.000h, L80/B10 / 3-step MacAdam

Power supply included.

IP20 | 230Vac | 50/60Hz



LED	4000K	Light Source	Luminaire
Power		32+63W	45+90W
Flux		4100+8200lm	1650+3300lm
Efficiency		129lm/W	37lm/W
LOR		-	40%
UGR		-	<25

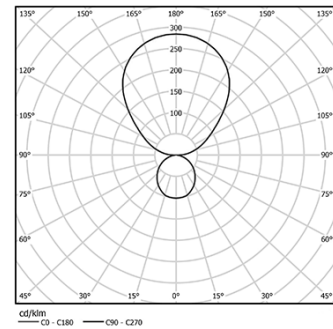

Application



Weight  
7Kg

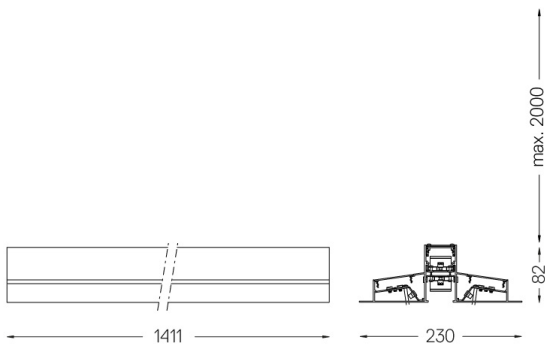

Finishes

- .01 White / RAL 9010
- .02 Black / RAL 9005
- .03 Grey / RAL 9006

Mandatory

54034 Clear base

Ø60x35mm

54080 Aluminium base

Ø60x37mm