

63+126W / 3300+6600lm / 3000K / DALI /
Diffuse Direct/ Indirect / 2821mm

64179



Design: Eduardo Souto de Moura
MGB Pendant Indirect module with housing made of aluminium profile with 25micron maximum corrosion resistance anodization with textured electrostatic 100% polyester paint.

Frosted acrylic diffuser with user friendly clipping system.

Steel end caps with textured electrostatic 100% polyester paint.

Frosted acrylic diffuser for direct light and indirect light.

Fitting accessories supplied separately.

LED CRI>80 / >50.000h, L80/B10 / 3-step MacAdam

Power supply included.

IP20 | 230Vac | 50/60Hz



LED	3000K	Light Source	Luminaire
Power	63+126W	8200+16400lm	3300+6600lm
Flux	130lm/W	-	37lm/W
Efficiency	-	40%	<25
LOR	-	-	-
UGR	-	-	-

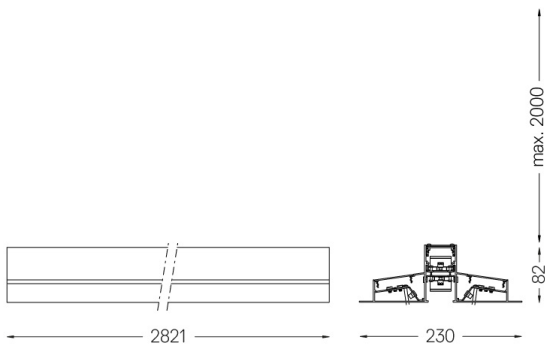
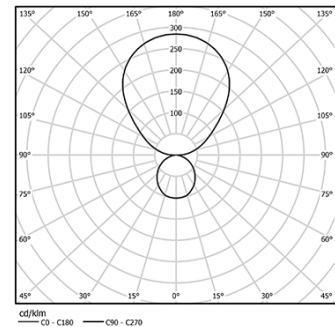

Finishes

- .01 White / RAL 9010
- .02 Black / RAL 9005
- .03 Grey / RAL 9006

Mandatory

- 56051 Clear base DALI
Ø60x35mm
- 54081 Aluminium base DALI
Ø60x37mm

For the specific supply of "DALI 2" drivers, please contact:
support@om-light.com