

23+45W / 850+1700lm / 2700K / DALI /
Diffuse Direct/ Indirect / 1411mm

64168



Design: Eduardo Souto de Moura
MGB Pendant Indirect module with housing made of aluminium profile with 25micron maximum corrosion resistance anodization with textured electrostatic 100% polyester paint.

Frosted acrylic diffuser with user friendly clipping system.

Steel end caps with textured electrostatic 100% polyester paint.

Frosted acrylic diffuser for direct light and indirect light.

Fitting accessories supplied separately.

LED CRI>90 / >50.000h, L80/B10 / 3-step MacAdam

Power supply included.

IP20 | 230Vac | 50/60Hz



LED	2700K	Light Source	Luminaire
Power	23+45W		33+65W
Flux	2125+4250lm		850+1700lm
Efficiency	94lm/W		26lm/W
LOR	-		40%
UGR	-		<25

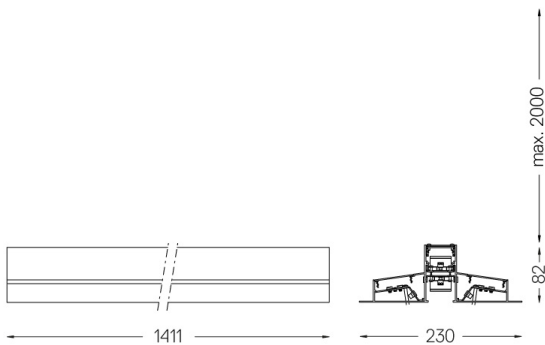
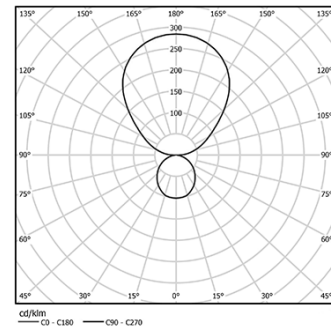

Finishes

- .01 White / RAL 9010
- .02 Black / RAL 9005
- .03 Grey / RAL 9006

Mandatory

56051 Clear base DALI

Ø60x35mm

54081 Aluminium base DALI

Ø60x37mm

For the specific supply of "DALI 2" drivers, please contact:
support@om-light.com