

90W / 4600lm / 4000K / DALI / Diffuse  
indirect / 2821mm

64142

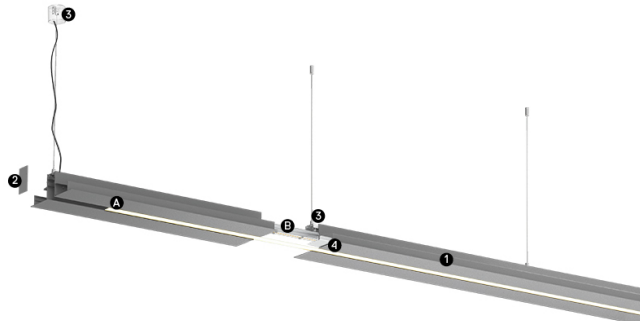

- |                       |                                |
|-----------------------|--------------------------------|
| <b>Structure</b>      | <b>Diffuser</b>                |
| 1 Profile             | A Polycarbonate frost diffuser |
| 2 End caps            |                                |
| 3 Fitting accessories | <b>Light Source</b>            |
| 4 Profile coupling    | B LED Modules                  |

Design: Eduardo Souto de Moura  
MGB Pendant Indirect module with housing made of aluminium profile with 25micron maximum corrosion resistance anodization with textured electrostatic 100% polyester paint.  
Frosted acrylic diffuser with user friendly clipping system.  
Steel end caps with textured electrostatic 100% polyester paint.  
Frosted acrylic diffuser for indirect light.  
Three-phase track (On/Off or DALI) for installing spotlights.  
Fitting accessories supplied separately.

LED CRI>80 / >50.000h, L80/B10 / 3-step MacAdam  
Power supply included.  
IP20 | 230Vac | 50/60Hz



LED	4000K	Light Source	Luminaire
Power	90W	11500lm	130W
Flux	11500lm	128lm/W	4600lm
Efficiency	128lm/W	-	35lm/W
LOR	-	-	40%
UGR	-	-	<25

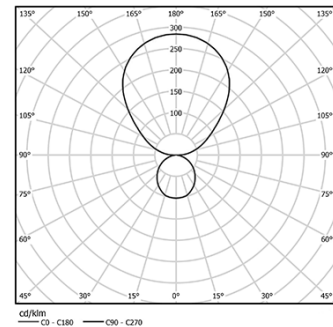

Beam angle  
Diffuse indirect

Application



Weight  
14Kg

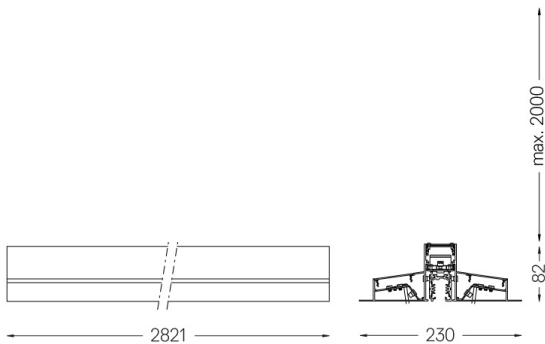

Finishes

- .01 White / RAL 9010
- .02 Black / RAL 9005
- .03 Grey / RAL 9006

Mandatory

- 56051 Clear base DALI  
Ø60x35mm
- 54081 Aluminium base DALI  
Ø60x37mm

For the specific supply of "DALI 2" drivers, please contact:  
support@om-light.com