

63W / 3300lm / 3000K / DALI / Diffuse
indirect / 1411mm

64133



Design: Eduardo Souto de Moura
MGB Pendant Indirect module with housing made of aluminium profile with 25micron maximum corrosion resistance anodization with textured electrostatic 100% polyester paint.

Frosted acrylic diffuser with user friendly clipping system.

Steel end caps with textured electrostatic 100% polyester paint.

Frosted acrylic diffuser for indirect light.

Three-phase track (On/Off or DALI) for installing spotlights.

Fitting accessories supplied separately.

LED CRI>80 / >50.000h, L80/B10 / 3-step MacAdam
Power supply included.
IP20 | 230Vac | 50/60Hz



LED	3000K	Light Source	Luminaire
Power		63W	90W
Flux		8200lm	3300lm
Efficiency		130lm/W	37lm/W
LOR		-	40%
UGR		-	<25

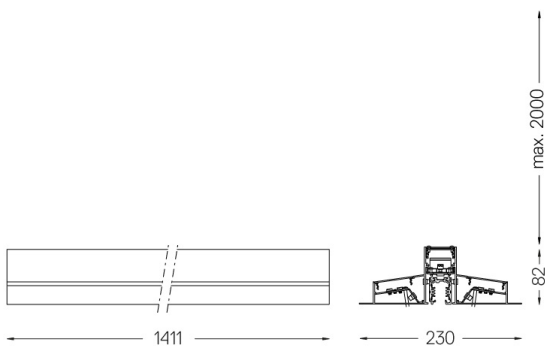
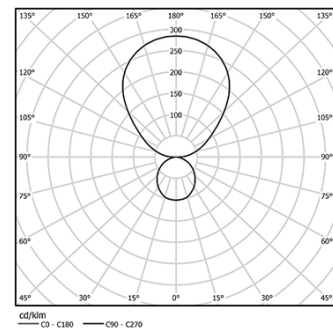

Finishes

- .01 White / RAL 9010
- .02 Black / RAL 9005
- .03 Grey / RAL 9006

Mandatory

- 56051 Clear base DALI
Ø60x35mm
- 54081 Aluminium base DALI
Ø60x37mm

For the specific supply of "DALI 2" drivers, please contact:
support@om-light.com