

126W / 4800lm / 2700K / On/Off / Diffuse
indirect / 2821mm

64123



Design: Eduardo Souto de Moura

MGB Pendant Indirect module with housing made of aluminium profile with 25micron maximum corrosion resistance anodization with textured electrostatic 100% polyester paint.

Frosted acrylic diffuser with user friendly clipping system.

Steel end caps with textured electrostatic 100% polyester paint.

Frosted acrylic diffuser for indirect light.

Three-phase track (On/Off or DALI) for installing spotlights.

Fitting accessories supplied separately.

LED CRI>90 / >50.000h, L80/B10 / 3-step MacAdam
Power supply included.
IP20 | 230Vac | 50/60Hz



LED	2700K	Light Source	Luminaire
Power	126W		180W
Flux	12000lm		4800lm
Efficiency	95lm/W		27lm/W
LOR	-		40%
UGR	-		<25



Application



Weight
14Kg

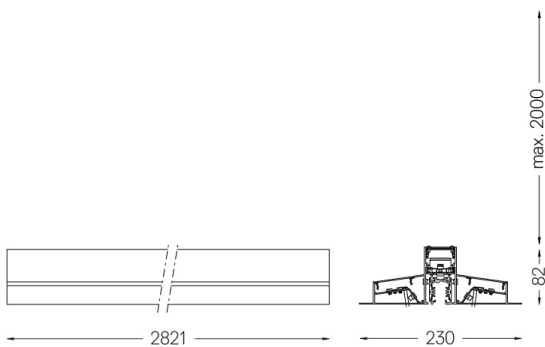

Finishes

- .01 White / RAL 9010
- .02 Black / RAL 9005
- .03 Grey / RAL 9006

Mandatory

- 54034 Clear base
Ø60x35mm
- 54080 Aluminium base
Ø60x37mm