

63W / 2400lm / 2700K / On/Off / Diffuse  
indirect / 1411mm

64121



Design: Eduardo Souto de Moura

MGB Pendant Indirect module with housing made of aluminium profile with 25micron maximum corrosion resistance anodization with textured electrostatic 100% polyester paint.

Frosted acrylic diffuser with user friendly clipping system.

Steel end caps with textured electrostatic 100% polyester paint.

Frosted acrylic diffuser for indirect light.

Three-phase track (On/Off or DALI) for installing spotlights.

Fitting accessories supplied separately.

LED CRI>90 / >50.000h, L80/B10 / 3-step MacAdam  
Power supply included.  
IP20 | 230Vac | 50/60Hz



LED	2700K	Light Source	Luminaire
Power	63W	90W	
Flux	6000lm	2400lm	
Efficiency	95lm/W	27lm/W	
LOR	-	40%	
UGR	-	<25	

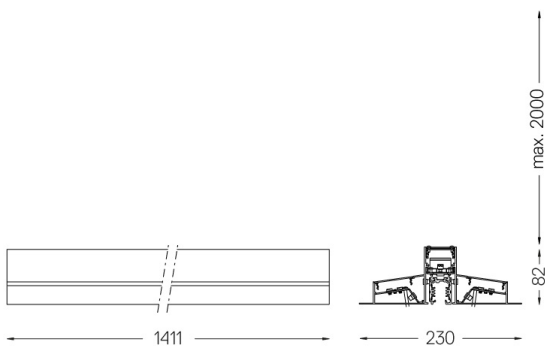

### Finishes

- .01 White / RAL 9010
- .02 Black / RAL 9005
- .03 Grey / RAL 9006

### Mandatory

- 54034 Clear base  
Ø60x35mm
- 54080 Aluminium base  
Ø60x37mm