

90W / 4600lm / 3000K / On/Off / Diffuse
indirect / 2821mm

64082



Design: Eduardo Souto de Moura
MGB Pendant Indirect module with housing made of aluminium profile with 25micron maximum corrosion resistance anodization with textured electrostatic 100% polyester paint.

Frosted acrylic diffuser with user friendly clipping system.

Steel end caps with textured electrostatic 100% polyester paint.

Frosted acrylic diffuser for direct light and indirect light.

Fitting accessories supplied separately.

LED CRI>80 / >50.000h, L80/B10 / 3-step MacAdam

Power supply included.

IP20 | 230Vac | 50/60Hz



LED	3000K	Light Source	Luminaire
Power		90W	130W
Flux		11500lm	4600lm
Efficiency		128lm/W	35lm/W
LOR		-	40%
UGR		-	<25



Beam angle
Diffuse indirect

Application



Weight
14Kg

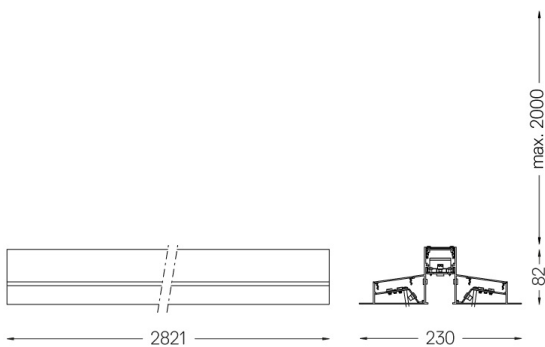

Finishes

- .01 White / RAL 9010
- .02 Black / RAL 9005
- .03 Grey / RAL 9006

Mandatory

54034 Clear base

Ø60x35mm

54080 Aluminium base

Ø60x37mm