

63W / 3300lm / 4000K / On/Off / Diffuse  
indirect / 1485mm

64065

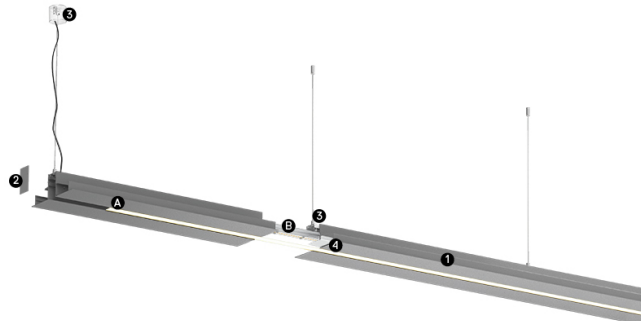

- |                       |                                |
|-----------------------|--------------------------------|
| <b>Structure</b>      | <b>Diffuser</b>                |
| 1 Profile             | A Polycarbonate frost diffuser |
| 2 End caps            |                                |
| 3 Fitting accessories | <b>Light Source</b>            |
| 4 Profile coupling    | B LED Modules                  |

Design: Eduardo Souto de Moura  
MGB Pendant Indirect module with housing made of aluminium profile with 25micron maximum corrosion resistance anodization with textured electrostatic 100% polyester paint.

Frosted acrylic diffuser with user friendly clipping system.

Steel end caps with textured electrostatic 100% polyester paint.

Frosted acrylic diffuser for direct light and indirect light.

Fitting accessories supplied separately.

LED CRI>80 / >50.000h, L80/B10 / 3-step MacAdam

Power supply included.

IP20 | 230Vac | 50/60Hz



LED	4000K	Light Source	Luminaire
Power		63W	90W
Flux		8200lm	3300lm
Efficiency		130lm/W	37lm/W
LOR		-	40%
UGR		-	<25

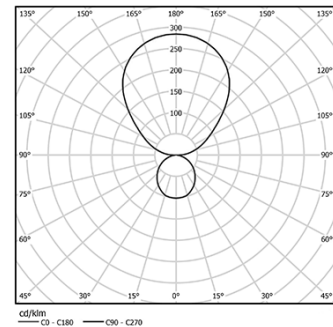

Beam angle  
Diffuse indirect

Application



Weight  
7Kg

mm

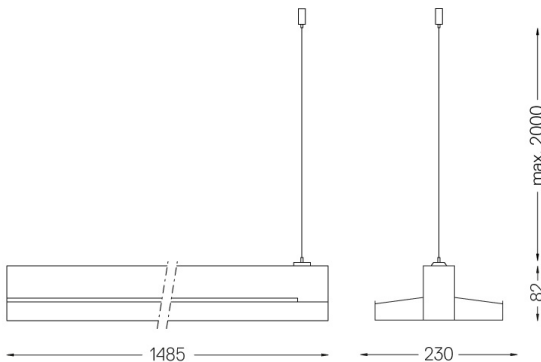

Finishes

- .01 White / RAL 9010
- .02 Black / RAL 9005
- .03 Grey / RAL 9006

Mandatory

54034 Clear base

Ø60x35mm

54080 Aluminium base

Ø60x37mm