

21W / 1890lm / 4000K / DALI / Medium 31° / 900mm

64016



### Structure

- 1 Profile
- 2 End caps
- 3 Fitting accessories
- 4 Profile coupling

### Modules

- A inVision Module

Design: O/M + Bartenbach GmbH  
inVision module with housing and perforated cover plate made of aluminium with textured-paint finish.

LED CRI>80 / >50.000h, L80/B10 / 2-step MacAdam  
Power supply included.  
IP20 | 230Vac | 50/60Hz



LED	4000K	Light Source	Luminaire
Power		21W	25,6W
Flux		2580lm	1890lm
Efficiency		123lm/W	74lm/W
LOR		-	73%
UGR		-	<10

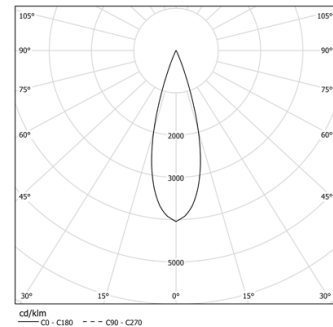

Beam angle  
Medium 31°

### Application



Weight  
0,6Kg

mm

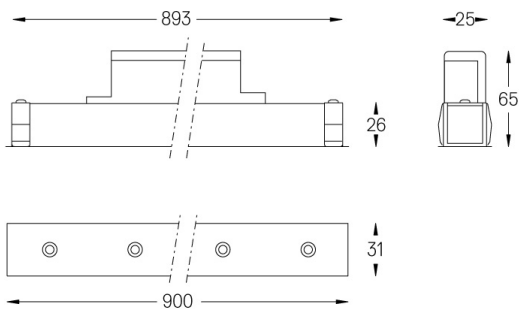

### Finishes

- .01 White / RAL 9010
- .02 Black / RAL 9005

For the specific supply of "DALI 2" drivers, please contact:  
support@om-light.com

Choose the length and layout of the system exactly as you want it, to model the right lighting functions for different tasks. For further information please contact: support@om-light.com