

21W / 1470lm / 3000K / DALI / Flood 52° / 900mm

64010



### Structure

- 1 Profile
- 2 End caps
- 3 Fitting accessories
- 4 Profile coupling

### Modules

- A inVision Module

Design: O/M + Bartenbach GmbH

inVision module with housing and perforated cover plate made of aluminium with textured-paint finish.

LED CRI>90 / >50.000h, L80/B10 / 2-step MacAdam

Power supply included.

IP20 | 230Vac | 50/60Hz



LED	3000K	Light Source	Luminaire
Power		21W	25,6W
Flux		1935lm	1470lm
Efficiency		92lm/W	57lm/W
LOR		-	76%
UGR		-	<10

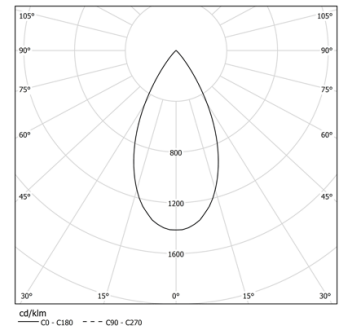

Beam angle  
Flood 52°

### Application



Weight  
0,6Kg

mm

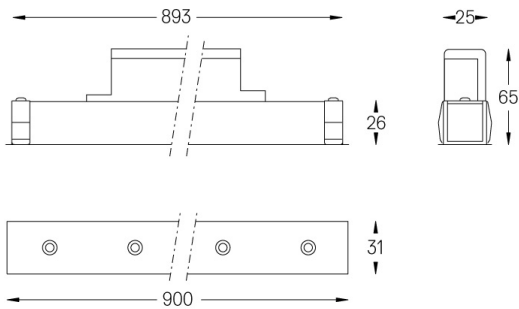

### Finishes

- .01 White / RAL 9010
- .02 Black / RAL 9005

For the specific supply of "DALI 2" drivers, please contact: support@om-light.com

Choose the length and layout of the system exactly as you want it, to model the right lighting functions for different tasks. For further information please contact: support@om-light.com