



Design: O/M + Bartenbach GmbH

Ceiling-recessed luminaire with die-cast aluminium body and heat sink.

Orientable by 30° on the horizontal axis and 355° on the vertical axis.

Reflector built based on micro surfaces with complex geometry coated with aluminium alloy, creating a high-gloss, entirely mirrored surface. Accurate reflector for a defined and controlled beam of light, achieving the maximum efficiency.

Reduced height <67mm.

Recessing accessory for trimless version supplied separately.

LED CRI>90 / >50.000h, L80/B10
2-step MacAdam / Power supply included.
IP20 | 230Vac | 50/60Hz



LED	3000K	Light Source	Luminaire
Power		4,5W	5,8W
Flux		520lm	300lm
Efficiency		116lm/W	52lm/W
LOR		-	58%
UGR		-	<10

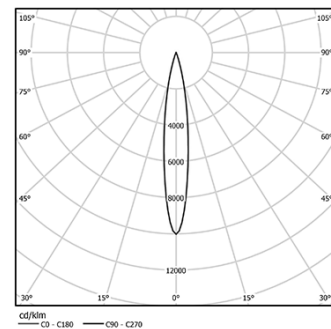

Beam angle
Spot 15°

Application



Weight
0,42Kg



Ø90 (trim version)

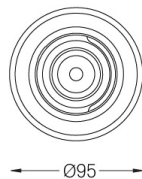
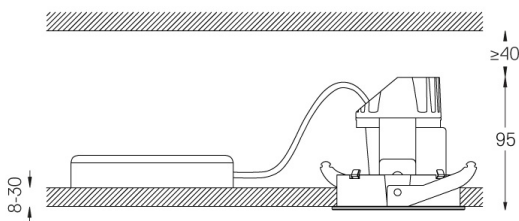

Finishes

- .01 White / RAL 9010
- .02 Black / RAL 9005
- .21 Black+White

Optional

59015 Accessory 12,5mm ceilings (flush installation)
150x101x20mm

The cutout dimensions are for plasterboard ceilings. For other type of material please contact: support@om-light.com

Data according to regulations

2019/2020/EU supplemented by 2021/341 | 2019/2015/EU supplemented by 2021/340/EU Energy Consumption Labelling Ordinance. This product contains a light source of efficiency class F
Model Identifier 2053560257L