

4,5W / 300lm / 3000K / DALI / Spot 15° /
ø85mm

63604



Design: O/M + Bartenbach GmbH

Surface/Pendant luminaire with aluminium die-cast body and heat sink with electrostatic 100% polyester paint finish.

Spot-lens with individual complex surface rips to provide a focal light and an extremely narrow beam. Fitting accessories ordered separately

LED CRI>90 / >50.000h, L80/B10
2-step MacAdam / Power supply included.
IP20 | 230Vac | 50/60Hz



LED	3000K	Light Source	Luminaire
Power	4,5W		5,8W
Flux	520lm		300lm
Efficiency	116lm/W		52lm/W
LOR	-		58%
UGR	-		<10



Beam angle
Spot 15°

Application



Weight
0,58Kg

mm

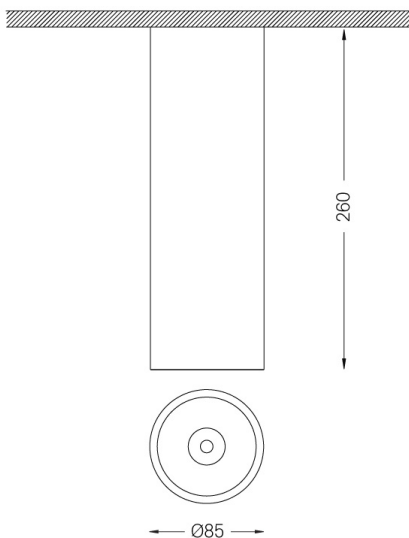

Finishes

- .01 White / RAL 9010
- .02 Black / RAL 9005

Mandatory

59051 Accessory for pendant installation
ø80x35mm

For the specific supply of "DALI 2" drivers, please contact:
support@om-light.com

Data according to regulations

2019/2020/EU supplemented by 2021/341 | 2019/2015/EU
supplemented by 2021/340/EU Energy Consumption Labelling
Ordinance. This product contains a light source of efficiency class F
Model Identifier 2053560257L