

One Adjustable

5,6W / 200lm / 2700K / DALI / Spot 15° / ø60mm

63564



Design: O/M + Bartenbach GmbH

Ceiling-recessed luminaire with aluminium die-cast body and heat sink with electrostatic 100% polyester paint finish.

Orientable by 20° horizontal rotation.

Spot-lens with individual complex surface rips to provide a focal light and an extremely narrow beam.

LED CRI>90 / >50.000h, L80/B10
2-step MacAdam / Power supply included.
IP20 | 230Vac | 50/60Hz



LED	2700K	Light Source	Luminaire
Power	5,6W		7W
Flux	440lm		200lm
Efficiency	79lm/W		29lm/W
LOR	-		45%
UGR	-		<10

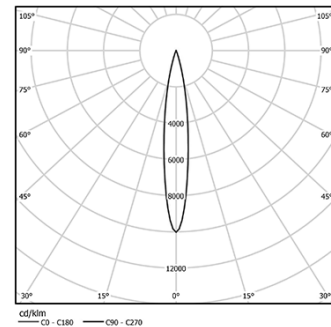

Beam angle
Spot 15°

Application



Weight
0,58Kg



Ø54

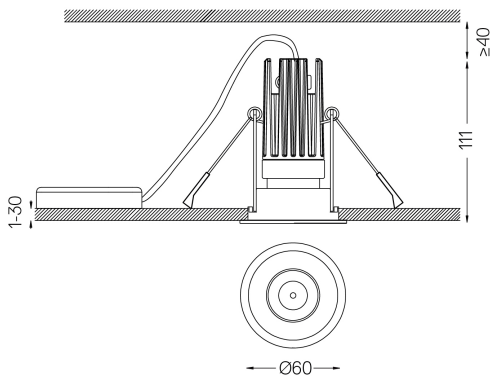

Finishes

- .01 White / RAL 9010
- .02 Black / RAL 9005

For the specific supply of "DALI 2" drivers, please contact:
support@om-light.com

The cutout dimensions are for plasterboard ceilings. For other type of material please contact: support@om-light.com

Data according to regulations

2019/2020/EU supplemented by 2021/341 | 2019/2015/EU supplemented by 2021/340/EU Energy Consumption Labelling Ordinance. This product contains a light source of efficiency class G Model Identifier 4053560312H