

5,6W / 410lm / 2700K / DALI / Flood 56° /
54x54mm

63541



Design: O/M + Bartenbach GmbH

Ceiling-recessed luminaire with aluminium die-cast body and heat sink with electrostatic 100% polyester paint finish.

Lightcore optics for defined and perfectly controlled beam of light.

Recessing accessory supplied separately.

LED CRI>90 / >50.000h, L80/B10
2-step MacAdam / Power supply included.
IP20 | 230Vac | 50/60Hz



LED	2700K	Light Source	Luminaire
Power	5,6W		7W
Flux	460lm		410lm
Efficiency	82lm/W		59lm/W
LOR	-		89%
UGR	-		<19

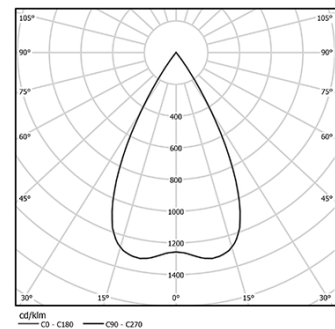

Beam angle
Flood 56°

Application



Weight

mm

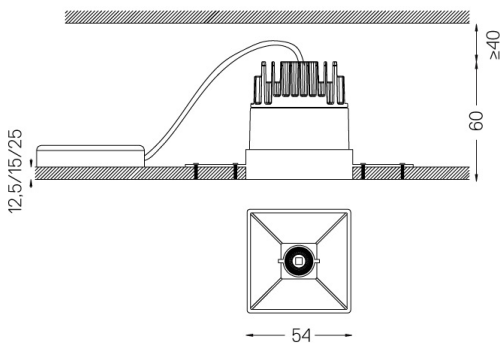

Finishes

- .01 White / RAL 9010
- .02 Black / RAL 9005

Mandatory

- 59045** Trimless accessory (12.5mm ceilings)
155x18mm
- 59046** Trimless accessory (15mm ceilings)
155x20mm
- 59047** Trimless accessory (25mm ceilings)
155x30mm

For the specific supply of "DALI 2" drivers, please contact:
support@om-light.com

The cutout dimensions are for plasterboard ceilings. For other type of material please contact: support@om-light.com

Data according to regulations

2019/2020/EU supplemented by 2021/341 | 2019/2015/EU supplemented by 2021/340/EU Energy Consumption Labelling Ordinance. This product contains a light source of efficiency class G Model Identifier 4053560312H