

5,6W / 350lm / 2700K / On/Off / Medium
40° / 54x54mm

63538

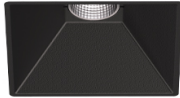

Design: O/M + Bartenbach GmbH

Ceiling-recessed luminaire with aluminium die-cast body and heat sink with electrostatic 100% polyester paint finish.

Lightcore optics for defined and perfectly controlled beam of light.

Recessing accessory supplied separately.

LED CRI>90 / >50.000h, L80/B10
2-step MacAdam / Power supply included.
IP20 | 230Vac | 50/60Hz



LED	2700K	Light Source	Luminaire
Power	5,6W		7W
Flux	460lm		350lm
Efficiency	82lm/W		50lm/W
LOR	-		76%
UGR	-		<10

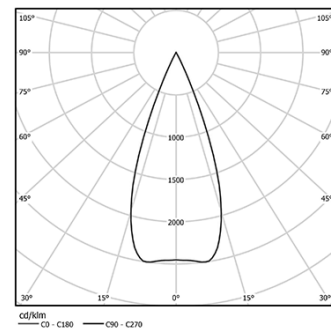

Beam angle
Medium 40°

Application



Weight

mm

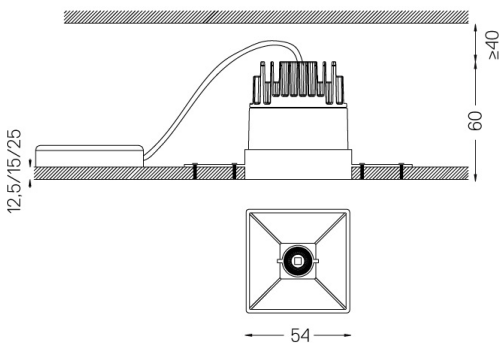

Finishes

- .01 White / RAL 9010
- .02 Black / RAL 9005

Mandatory

- 59045** Trimless accessory (12.5mm ceilings)
155x18mm
- 59046** Trimless accessory (15mm ceilings)
155x20mm
- 59047** Trimless accessory (25mm ceilings)
155x30mm

The cutout dimensions are for plasterboard ceilings. For other type of material please contact: support@om-light.com

Data according to regulations

2019/2020/EU supplemented by 2021/341 | 2019/2015/EU
supplemented by 2021/340/EU Energy Consumption Labelling
Ordinance. This product contains a light source of efficiency class G
Model Identifier 4053560312H

One Square Trimless

Trimless accessory (12.5mm
ceilings)

59045



67x67



Trimless accessory One 60x60
For 12.5mm ceilings.

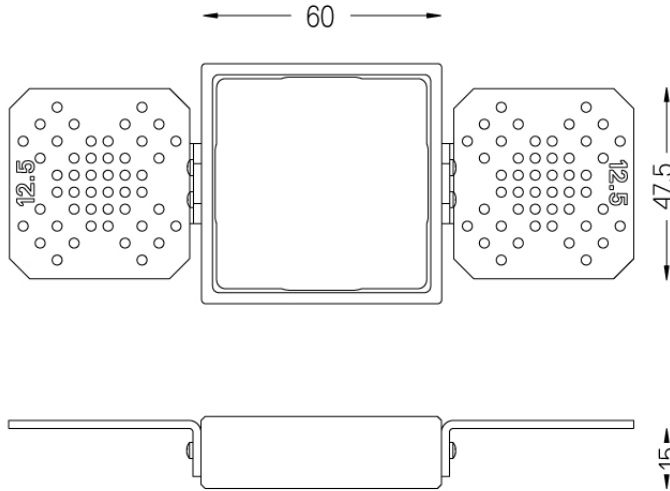

Weight
0,01Kg

Finishes
○ .01 White / RAL 9010

One Square Trimless

Trimless accessory (15mm
ceilings)

59046



67x67



Trimless accessory One 60x60
For 15mm ceilings.

Weight
0,01Kg

Finishes
○ .01 White / RAL 9010

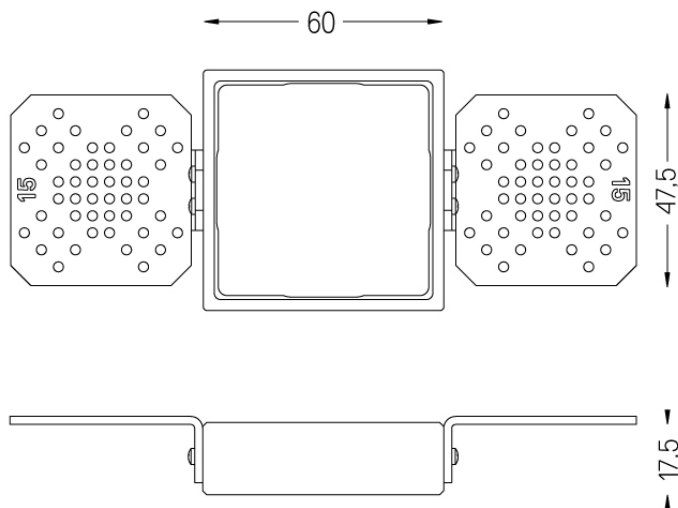

One Square Trimless

Trimless accessory (25mm
ceilings)

59047



67x67

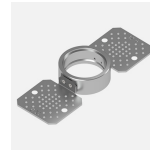

Trimless accessory One 60x60
For 25mm ceilings.

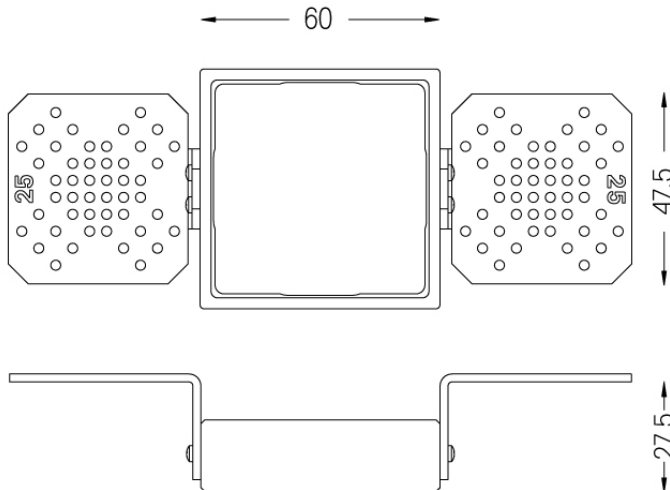

Weight
0,01Kg

Finishes
○ .01 White / RAL 9010