

5,6W / 410lm / 3000K / DALI / Flood 56° /
ø54mm

63518



Design: O/M + Bartenbach GmbH

Ceiling-recessed luminaire with aluminium die-cast body and heat sink with electrostatic 100% polyester paint finish.

Lightcore optics for defined and perfectly controlled beam of light.

Recessing accessory supplied separately.

LED CRI>90 / >50.000h, L80/B10
2-step MacAdam / Power supply included.
IP20 | 230Vac | 50/60Hz



LED	3000K	Light Source	Luminaire
Power	5,6W		7W
Flux	460lm		410lm
Efficiency	82lm/W		59lm/W
LOR	-		89%
UGR	-		<19

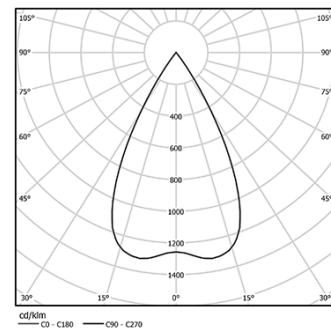

Beam angle
Flood 56°

Application



Weight

mm

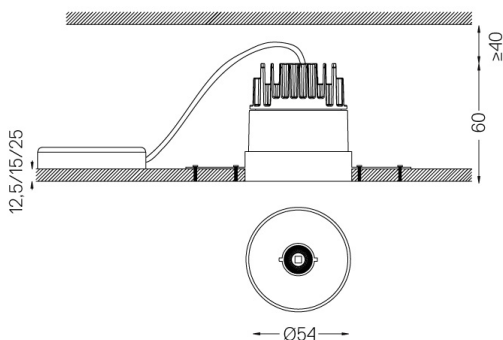

Finishes

- .01 White / RAL 9010
- .02 Black / RAL 9005

Mandatory

- 59039** Trimless accessory (12.5mm ceilings)
155x18mm
- 59040** Trimless accessory (15mm ceilings)
155x20mm
- 59041** Trimless accessory (25mm ceilings)
155x30mm

Optional

- 59083** Removal tool

For the specific supply of "DALI 2" drivers, please contact:
support@om-light.com

The cutout dimensions are for plasterboard ceilings. For other type of material please contact: support@om-light.com

Data according to regulations

2019/2020/EU supplemented by 2021/341 | 2019/2015/EU
supplemented by 2021/340/EU Energy Consumption Labelling
Ordinance. This product contains a light source of efficiency class G
Model Identifier 4053560290H

One Trimless

Trimless accessory (12.5mm
ceilings)

59039

1 mm

Ø65



Trimless accessory One ø60
For 12.5mm ceilings.

Weight
0,01Kg

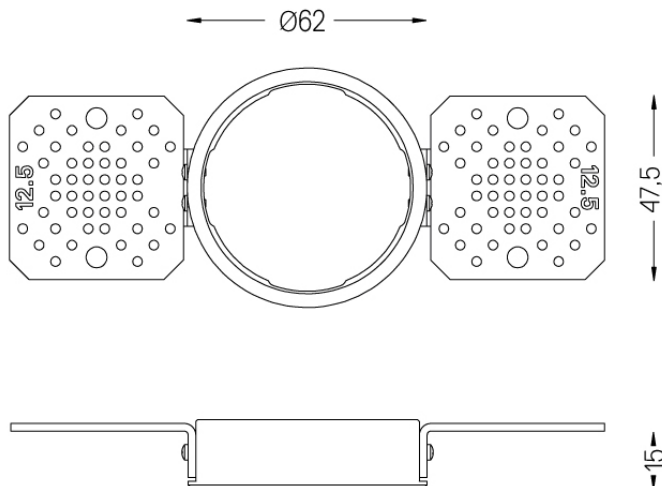

One Trimless

Trimless accessory (15mm
ceilings)

59040



Ø65



Trimless accessory One ø60
For 15mm ceilings.

Weight
0,01Kg

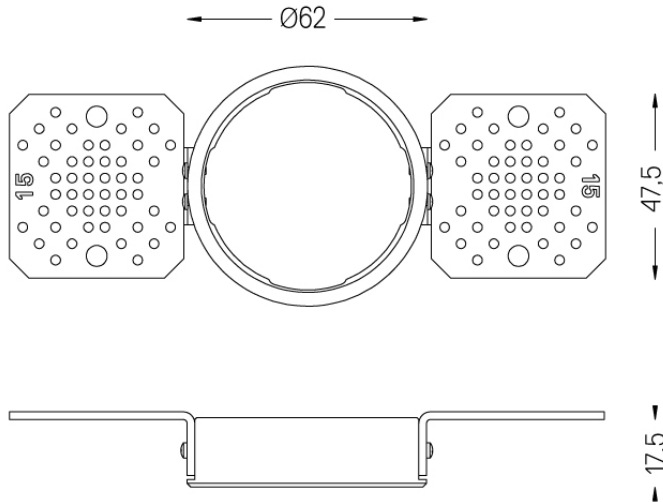

One Trimless

Trimless accessory (25mm
ceilings)

59041



Ø65



Trimless accessory One ø60
For 25mm ceilings.

Weight
0,01Kg

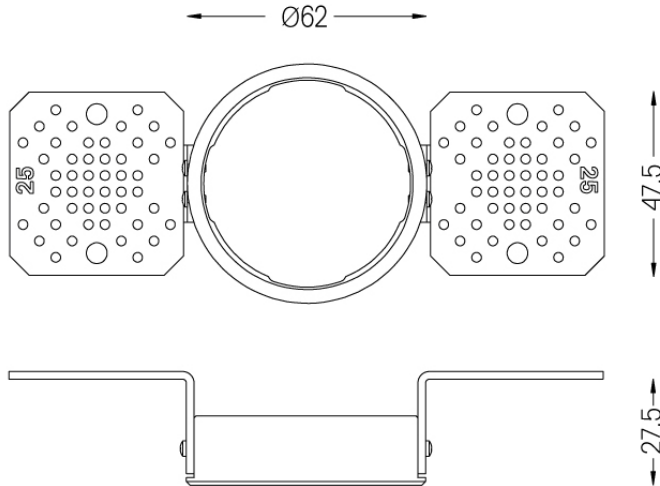

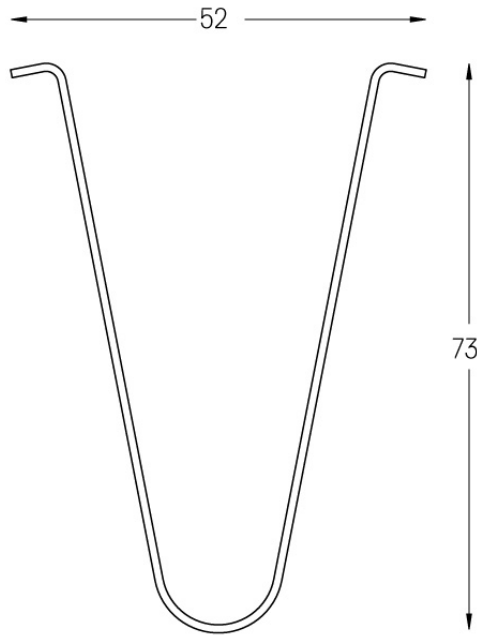

Removal tool

59083



Removal tool for Spot on
luminaires.

Finishes
.99