

5,9W / 630lm / 4000K / On/Off /
Asymmetric / ø60mm

63468

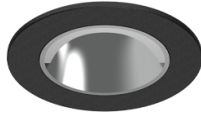

Design: O/M + Bartenbach GmbH

Ceiling-recessed luminaire with aluminium die-cast body and heat sink with electrostatic 100% polyester paint finish.

Accurate reflector for a defined and controlled beam of light, achieving maximum efficiency.

Fitting accessories for different applications are available.

LED CRI>80 / >50.000h, L80/B10
2-step MacAdam / Power supply included.
IP20 | 230Vac | 50/60Hz



LED	4000K	Light Source	Luminaire
Power		5,9W	7,4W
Flux		740lm	630lm
Efficiency		125lm/W	85lm/W
LOR		-	85%
UGR		-	-

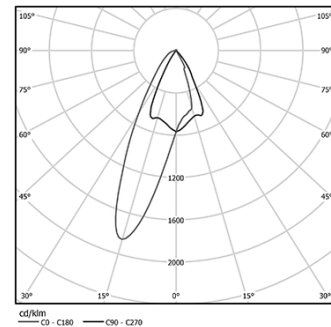

Beam angle
Asymmetric

Application



Weight



Ø53

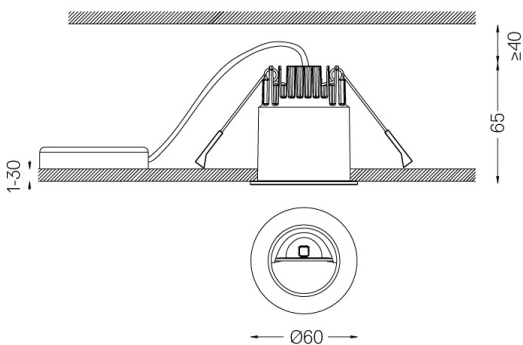

Finishes

- .01 White / RAL 9010
- .02 Black / RAL 9005

The cutout dimensions are for plasterboard ceilings. For other type of material please contact: support@om-light.com

Data according to regulations

2019/2020/EU supplemented by 2021/341 | 2019/2015/EU supplemented by 2021/340/EU Energy Consumption Labelling Ordinance. This product contains a light source of efficiency class E Model Identifier 4053560100