

5,6W / 350lm / 3000K / DALI / Medium 40° /  
ø60mm

63463



Design: O/M + Bartenbach GmbH

Ceiling-recessed luminaire with aluminium die-cast body and heat sink with electrostatic 100% polyester paint finish.

Lightcore optics for defined and perfectly controlled beam of light.

Easy recessing system with spring clips.

LED CRI>90 / >50.000h, L80/B10  
2-step MacAdam / Power supply included.  
IP20 | 230Vac | 50/60Hz



LED	3000K	Light Source	Luminaire
Power		5,6W	7W
Flux		460lm	350lm
Efficiency		82lm/W	50lm/W
LOR		-	76%
UGR		-	<10



Beam angle  
Medium 40°

Application



Weight  
0,28Kg



Ø53

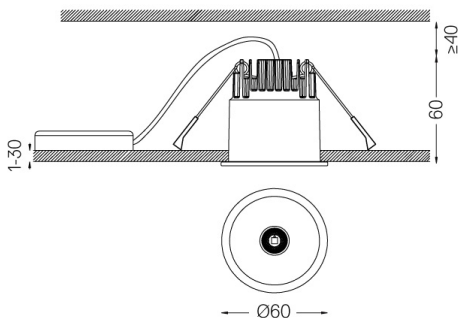

Finishes

- .01 White / RAL 9010
- .02 Black / RAL 9005

For the specific supply of "DALI 2" drivers, please contact:  
support@om-light.com

The cutout dimensions are for plasterboard ceilings. For other type of material please contact: support@om-light.com

Data according to regulations

2019/2020/EU supplemented by 2021/341 | 2019/2015/EU supplemented by 2021/340/EU Energy Consumption Labelling Ordinance. This product contains a light source of efficiency class G Model Identifier 4053560290H