

5,6W / 350lm / 2700K / On/Off / Medium
40° / ø60mm

63454



Design: O/M + Bartenbach GmbH

Ceiling-recessed luminaire with aluminium die-cast body and heat sink with electrostatic 100% polyester paint finish.

Lightcore optics for defined and perfectly controlled beam of light.

Easy recessing system with spring clips.

LED CRI>90 / >50.000h, L80/B10
2-step MacAdam / Power supply included.
IP20 | 230Vac | 50/60Hz



LED	2700K	Light Source	Luminaire
Power	5,6W		7W
Flux	460lm		350lm
Efficiency	82lm/W		50lm/W
LOR	-		76%
UGR	-		<10



Beam angle
Medium 40°

Application



Weight
0,28Kg



Ø53

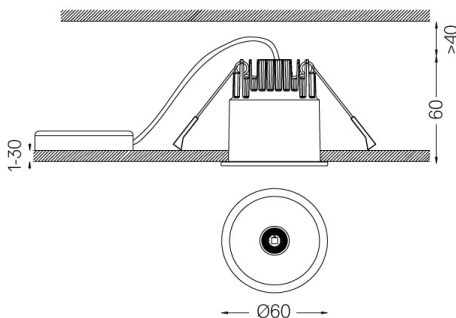

Finishes

- .01 White / RAL 9010
- .02 Black / RAL 9005

The cutout dimensions are for plasterboard ceilings. For other type of material please contact: support@om-light.com

Data according to regulations

2019/2020/EU supplemented by 2021/341 | 2019/2015/EU supplemented by 2021/340/EU Energy Consumption Labelling Ordinance. This product contains a light source of efficiency class G Model Identifier 4053560312H