

Beam Adjustable

10W / 1150lm / 4000K / On/Off / Flood 46° / ø100mm

63228



Design: O/M

Ceiling-recessed luminaire made of aluminium die-cast.

Adjustable version (orientable by 30° on the horizontal axis and 355° on the vertical axis).

Recessing accessory for flush version supplied separately.

LED CRI>80 / >50.000h, L80/B10
3-step MacAdam / Power supply included.
IP20 | 230Vac | 50/60Hz



LED	4000K	Light Source	Luminaire
Power	10W		12,5W
Flux	1450lm		1150lm
Efficiency	145lm/W		92lm/W
LOR	-		79%
UGR	-		<22

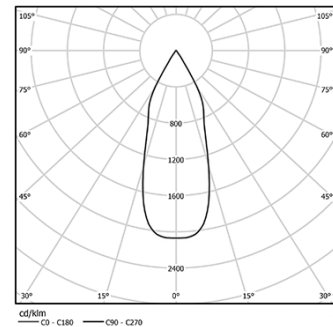

Beam angle
Flood 46°

Application



Weight
0,5Kg



∅95 (trim version)

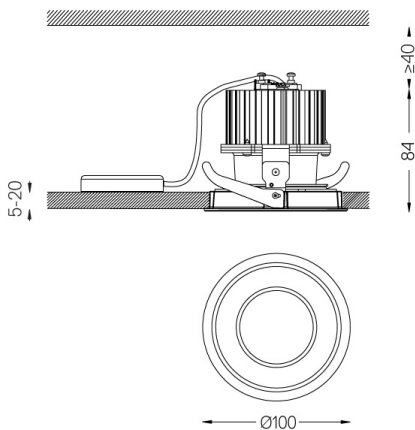

Finishes

- .04 Matt White
- .05 Matt Black

Optional

- 59066** Flush accessory (12.5mm ceilings)
201x17mm
- 59067** Flush accessory (15mm ceilings)
201x19,5mm
- 59068** Flush accessory (25mm ceilings)
201x29,5mm

The cutout dimensions are for plasterboard ceilings. For other type of material please contact: support@om-light.com

Data according to regulations

2019/2020/EU supplemented by 2021/341 | 2019/2015/EU supplemented by 2021/340/EU Energy Consumption Labelling Ordinance. This product contains a light source of efficiency class E Model Identifier BXRC-40E2000-C-73