

Beam Adjustable

10W / 900lm / 3000K / DALI / Medium 28° / ø100mm

63222



Design: O/M

Ceiling-recessed luminaire made of aluminium die-cast.

Adjustable version (orientable by 30° on the horizontal axis and 355° on the vertical axis).

Recessing accessory for flush version supplied separately.

LED CRI>80 / >50.000h, L80/B10
3-step MacAdam / Power supply included.
IP20 | 230Vac | 50/60Hz



LED	3000K	Light Source	Luminaire
Power	10W		12,5W
Flux	1200lm		900lm
Efficiency	120lm/W		72lm/W
LOR	-		75%
UGR	-		<19

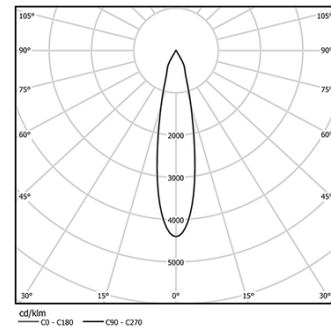

Beam angle
Medium 28°

Application



Weight
0,5Kg



∅95 (trim version)

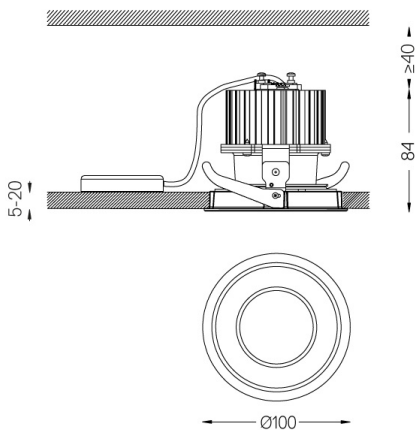

Finishes

- .04 Matt White
- .05 Matt Black

Optional

- 59066** Flush accessory (12.5mm ceilings)
201x17mm
- 59067** Flush accessory (15mm ceilings)
201x19,5mm
- 59068** Flush accessory (25mm ceilings)
201x29,5mm

For the specific supply of "DALI 2" drivers, please contact:
support@om-light.com

The cutout dimensions are for plasterboard ceilings. For other type of material please contact: support@om-light.com

Data according to regulations

2019/2020/EU supplemented by 2021/341 | 2019/2015/EU supplemented by 2021/340/EU Energy Consumption Labelling Ordinance. This product contains a light source of efficiency class E Model Identifier BXRC-30E2000-C-73