

Tube Evo

29W / 2400lm / 4000K / DALI / Super spot
10° / 1539mm

63136



Design: O/M

Surface luminaire with tubular shock-resistant clear polycarbonate diffuser and anti-condensation system comprising a valve that prevents condensation within the luminaire without affecting its high level of protection.

End caps in clear polycarbonate with marked installation angles.

Optic system with acrylic lens.

Equipped with 1m cable (H05RN-F) and a metallic cable gland.

Fitting accessories and IP68 connector supplied separately.

LED CRI>80 / >50.000h, L80/B10 / 3-step MacAdam

Power supply included.

IP67 | IK08 | 230Vac | 50/60Hz



LED	4000K	Light Source	Luminaire
Power		29W	35,4W
Flux		3240lm	2400lm
Efficiency		112lm/W	67lm/W
LOR		-	84%
UGR		-	<10

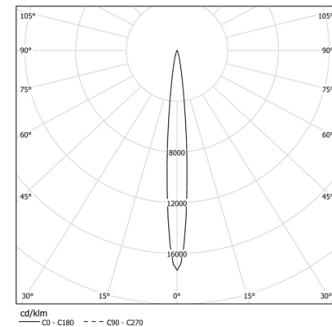

Beam angle
Super spot 10°

Application



Weight
1,4Kg

mm

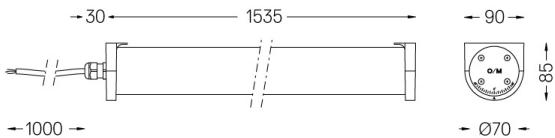

Finishes

● .20 Clear

Mandatory

43707 Surface fitting accessory

Optional

43431 IP68 Connector

5 poles

For the specific supply of "DALI 2" drivers, please contact:
support@om-light.com

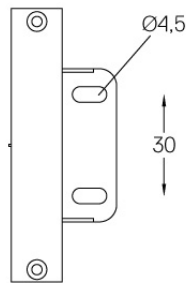
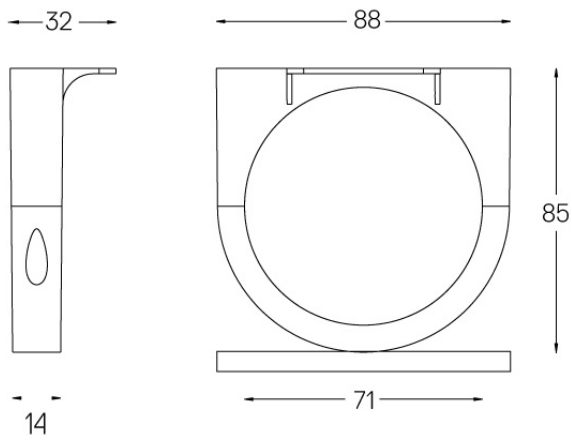

Set of 2 fitting accessories for surface version.

Finishes

● .20 Clear



Tube Evo IP68 Connector
5 poles, Ø7 to Ø12mm

Weight
0,04Kg

