

Tube Evo

59W / 4800lm / 3000K / On/Off / Super spot
10° / 1539mm

63119



Design: O/M

Surface luminaire with tubular shock-resistant clear polycarbonate diffuser and anti-condensation system comprising a valve that prevents condensation within the luminaire without affecting its high level of protection.

End caps in clear polycarbonate with marked installation angles.

Optic system with acrylic lens.

Equipped with 1m cable (H05RN-F) and a metallic cable gland.

Fitting accessories and IP68 connector supplied separately.

LED CRI>90 / >50.000h, L80/B10 / 3-step MacAdam

Power supply included.

IP67 | IK08 | 230Vac | 50/60Hz



LED	3000K	Light Source	Luminaire
Power		59W	69,4W
Flux		5790lm	4800lm
Efficiency		98lm/W	69lm/W
LOR		-	83%
UGR		-	<10

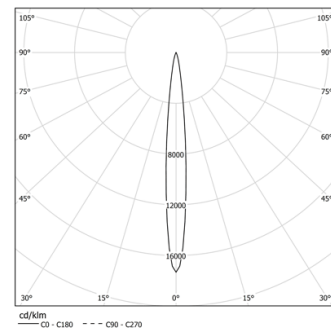

Beam angle
Super spot 10°

Application



Weight
1,4Kg

mm

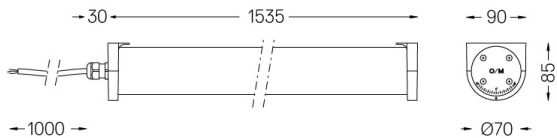

Finishes

● .20 Clear

Mandatory

43707 Surface fitting accessory

Optional

43430 IP68 Connector

4 poles



Set of 2 fitting accessories for surface version.

Finishes

● .20 Clear



Tube Evo IP68 Connector
4 poles, Ø7 to Ø12mm

Weight
0,004Kg

